



Heteroatom stabilized carbenium ions

Hansjörg Grützmacher *, Christina M. Marchand

ETH Zürich, Laboratorium für Anorganische Chemie, Universitätsstrasse 6, CH-8092 Zürich, Switzerland

Received 18 December 1996; accepted 6 May 1997

Contents

Abstract	288
1. Introduction	288
2. Carbenium ions stabilized by alkali (Li, Na) and alkaline earth metals (Be, Mg)	291
2.1. Quantum mechanical calculations	291
2.2. Experimental results	292
3. Carbenium ions stabilized by heteroatoms from group 13 (B, Al)	292
3.1. Quantum mechanical calculations	292
3.2. Experimental results	293
4. Carbenium ions stabilized by elements of group 14	294
4.1. Quantum mechanical calculations	294
4.2. Experimental results	295
5. Carbenium ions stabilized by elements of group 15 (N, P, As, Sb)	296
5.1. Quantum mechanical calculations	296
5.2. Experimental results	303
5.2.1. Nitrogen substituted carbenium ions	303
5.2.2. Phosphorus substituted carbenium ions	305
5.2.2.1. Synthesis of methylenephosphonium ions	305
5.2.2.2. Reactivity of methylenephosphonium ions	308
6. Carbenium stabilized by heteroatoms from group 16 (O, S, Se, Te)	312
6.1. Quantum mechanical calculations	312
6.2. Experimental results	320
6.2.1. Synthesis and physical properties of chalcogeno-substituted carbenium ions	320
6.2.2. Reactivity of chalcogeno-substituted carbenium ions	326
7. Carbenium ions stabilized by heteroatoms from group 17 (F, Cl, Br, I)	329
7.1. Quantum mechanical calculations	329
7.2. Experimental results	334
8. Conclusions	337
Acknowledgements	340

* Corresponding author. Fax: +41 1 632 1090; e-mail: gruetz@inorg.chem.ethz.ch

Abstract

A comprehensive overview of α -heteroatom stabilized carbocations is presented, with special emphasis on mono-, di- and tri-substituted acyclic carbocations. The electronic effects of all main group elements on the stability of these compounds were systematically investigated and the calculated data is compared with experimental data. There are three electronic mechanisms by which a formally electron deficient center can be stabilized: (i) positive σ -induction by an electropositive element, (ii) π -donation from non-bonding electron pairs and (iii) positive hyperconjugation. One criterion for the stability of the cation is the stabilization energy calculated according to the isodesmic reaction: $H_{3-n}C(XH_m)_n^{\oplus} + nCH_4 \rightarrow nH_3CXH_m + CH_3^{\oplus}$. Stabilization energies obtained by isodesmic reactions may be problematic because of ground state effects of the species involved in the reactions. Nevertheless it was found that all the α -heteroelements from groups 1, 2, and 13 to 17 stabilize a carbenium ion with respect to the parent methenium ion CH_3^{\oplus} . For the alkali and alkaline earth metals this stabilization can be explained by positive σ -charge transfer, where the positive charge on the central carbon is reduced. For group 13, the stabilization consists of a mixture between σ -effects and hyperconjugation.

It is generally believed that the most efficient stabilizing effect evoked by a heteroatom adjacent to a formally electron deficient carbon center is due to π -charge transfer from a free electron pair on the heteroatom. Remarkably, the CLi_3^+ ion and the guanidinium ion, $C(NR_2)_3^+$, are the most stable carbenium ions with respect to CH_3^+ and they demonstrate that σ -donation can be as efficient as π -donation. The decrease in the calculated stability in the series of mono-substituted carbenium ions $(H_2X)CH_2^{\oplus}$ where $X = N, P, As$ and Sb , is due to an increase in the energy which is needed for planarization of the H_2X group in order to allow effective π -donation. However, when the planarization energies are taken into account, π -donor centers from the higher periods are not worse π -donors than elements from the second period! Generally, the influence of an α -heteroatom on the stability of a carbenium ion changes strongly along a period but hardly changes within a group. Even very electronegative elements can stabilize a carbocation by σ -attraction due to a large contribution of the Coulomb term to the binding energies. Analysis of the Laplacians of the electron density showed, however, that a minimum of charge transfer by π -donation of the electronegative α -heteroatom is necessary in order to concentrate sufficient charge in the C–X binding region and form a highly polar but localized bond. Furthermore, an overview of various experimental methods used to synthesize α -heteroelement substituted carbenium ions is given and some principles of their reactivity are discussed. © 1997 Elsevier Science S.A.

Keywords: Ab initio calculations; Carbenium ions; Carbocations; Heteroatoms; Isodesmic reactions; Laplacians; Preparations; Stabilization energies

1. Introduction

Certainly a large part of the beauty of chemistry as a science lies in the experimental verification of a theoretical hypothesis which itself stems from an experimental observation. This general statement is particularly true in carbocation chemistry. The first carbenium ion was observed by Norris and Kehrman when triphenylmethanol was dissolved in concentrated sulfuric acid [1,2] and Baeyer recognized the salt like character of the product $Ph_3C^{\oplus} HSO_4^-$ in 1902 [3]. At the same time, Wagner

observed rearrangements of terpenes which were later explained by Meerwein assuming carbenium ions as intermediates [4]. These theories were extended by Whitmore [5] and in the nineteen thirties Ingold coined the concepts of S_N1 and S_N2 mechanisms studying substitution reactions at carbon centers with a sp^3 -valence configuration [6]. The S_N1 mechanism proceeds via the rate determining formation of a carbenium ion. Solvolysis reactions involving the possible intermediacy of carbenium ions became a preferred topic of physical organic chemistry. However, the direct observation of carbocations by spectroscopic methods remained impossible until Olah could observe the Me_3C^{\oplus} cation generated from Me_3C-F using SbF_5 as Lewis acid in liquid SO_2 [7]. “Super acids” as reaction media for the generation of persistent carbocations were established [8]. The introduction of mass spectroscopy as an analytical technique made possible the observation of carbenium ions and their reactivity in the gas phase and the evolution of quantum mechanical methods led to a profound understanding of the physical data, reactivity and stability of these species. In five volumes edited by Olah and Schleyer, the knowledge about carbocations up to 1976 was documented [9] and successive reviews continuously update the progress in this research area [10–16]. The isolation and crystallization of carbocations as salts remain a challenge and only the recent work by Laube et al. allowed the comparison of the theoretical predictions concerning the structure of carbocations with experimental data obtained by X-ray analysis [17].

Carbenium ions with threefold coordinated carbon centers appeal to synthetic chemists because upon combination with a nucleophile molecules are easily constructed by a salt metathesis reaction. Therefore, the wish for “stabilized” carbenium ions which can be isolated, weighed in a flask and further manipulated is understandable. The formally highly electrophilic carbon center in a carbenium ion may be stabilized by three electronic mechanisms: (i) positive σ -induction of an electropositive substituent X, (ii) π -donation from non-bonding electron pairs residing on a heteroatom X in the α -position and (iii) positive hyperconjugation whereby a $R-X$ σ -bond in the α -position serves as electron donor. In Scheme 1 these mechanisms are visualized using resonance structures and it is obvious within this terminology that with increased number of heteroatoms the number of resonance structures and simultaneously the stability of the cation increases.

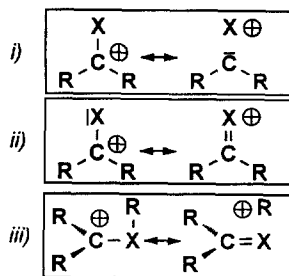

Scheme 1. Resonance structures of heteroatom X stabilized carbenium ions.

In the present report we attempt to describe more recent advances of the chemistry of α -heteroatom stabilized carbenium ions with particular emphasis on heteroatoms from the higher periods (principal quantum number $j > 2$). We think these are not only interesting synthons themselves, but may become promising candidates to study even polycations. Among them diprotonated carbonyl compounds (i.e. oxygen stabilized dications derived from ketones, esters and carbonic acids) are assumed as highly reactive “superelectrophiles” [15]. These polycations can be prepared by “charge stripping experiments” in the gas phase [18] or even isolated as is exemplified by the $[(\text{Me}_2\text{N})_2\text{C}-\text{C}(\text{NMe}_2)_2]^{2\oplus}$ dication which is the heteroatom stabilized analogue of the ethylene dication $[\text{C}_2\text{H}_4]^{2\oplus}$ [19].

We will begin our discussion with carbenium ions in which exclusively heteroatoms of groups 1, 2, 13 (Li, Na, K, Be, Mg, B, Al, etc.) or 14 (Si, Ge, Sn, Pb) are bound in α -position to the carbon center and hence mechanisms (i) and/or (ii) may be applied to describe the electronic stabilization of these carbenium ions. Subsequently, we will discuss results obtained studying substituted carbenium ions with heteroatoms from groups 15, 16 and 17. We will exclude generally cyclic systems [20–23] in which often the formal electron demand of the carbon center is balanced by an unsaturated – eventually aromatic – π -system (i.e. pyrilium, imidazolium salts etc.) and transition metal substituted cations (i.e. cationic carbene complexes). We note, furthermore, that there is an extensive body of information on oxygen- [protonated or alkylated aldehydes, ketones, carbonic esters (Meerwein salts) and acids], nitrogen- [iminium, amidinium and guanidinium salts], and sulfur- [20,24] substituted carbenium ions. Many of them are commercially available. Their syntheses and reactions are broadly discussed in the cited review literature and are therefore only briefly mentioned here [7,9,15,16,18–20,24].

In Fig. 1, the heteroatoms binding in the α -position to carbon in a carbenium ion are shown in the form of a three-dimensional periodic system. This was first introduced by Allen [25]. For our purposes we use relative spectroscopic electro-

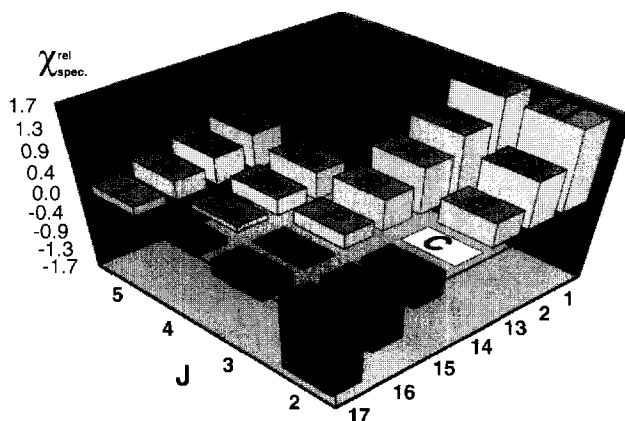

Fig. 1. Relative spectroscopic electronegativities, $\chi_{\text{spec}}^{\text{rel}}$, of group 1–2 and 13–17 elements which were considered as α -heteroatoms in carbenium ions $(\text{RX})_n\text{CH}_3^{\oplus-n}$.

negativities, $\chi_{\text{spec}}^{\text{rel}}$, setting the electronegativity of carbon arbitrarily to zero, i.e. $\chi_{\text{spec}}^{\text{rel}} = \chi_{\text{spec}}^{\text{C}} - \chi_{\text{spec}}^{\text{El}}$ where $\chi_{\text{spec}}^{\text{C}} = 2.544$ and $\chi_{\text{spec}}^{\text{El}}$ = experimentally derived value of χ_{spec} .

2. Carbenium ions stabilized by alkali (Li, Na) and alkaline earth metals (Be, Mg)

2.1. Quantum mechanical calculations

The stabilizing or destabilizing effect of replacing hydrogen atoms in CH_3^{\oplus} by heteroatoms X in the α -position can be calculated by means of the isodesmic reaction (1):

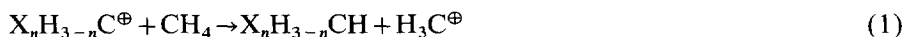

For α -lithium substituted carbenium ions LiCH_2^{\oplus} , $\text{Li}_2\text{CH}^{\oplus}$ and $\text{Li}_3\text{C}^{\oplus}$ the calculated reaction energy SE of Eq. (1) is positive which means that the cation is stabilized relative to the methyl cation CH_3^{\oplus} [26–30]. At various computational levels including electron correlation up to MP4 level the α -lithio substituted cations were found to be remarkably stable. LiCH_2^{\oplus} is about 77 kcal mol^{-1} more stable than CH_3^{\oplus} . Each additional lithium atom stabilizes the carbenium ion further, $\text{Li}_2\text{CH}^{\oplus}$ is $124 \text{ kcal mol}^{-1}$, $\text{Li}_3\text{C}^{\oplus}$ $145.3 \text{ kcal mol}^{-1}$ more stable than CH_3^{\oplus} , when the singlet states of these cations are compared [27]. The cations $\text{Li}_2\text{CH}^{\oplus}$ and $\text{Li}_3\text{C}^{\oplus}$, however, possess triplet ground states leading to SE 's which are increased somewhat by the triplet–singlet excitation energy. Formally, these cations can be described as singlet or triplet carbene CH_2 complexes of Li^{\oplus} . The relative stabilization is even larger for NaCH_2^{\oplus} and SE 's of $88.7 \text{ kcal mol}^{-1}$ (MP4SDTQ//6-31G* [29]) and $90.8 \text{ kcal mol}^{-1}$ (6-31G**) result compared to CH_3^{\oplus} . According to Eq. (1) evaluated SE 's of alkaline earth metal substituted carbenium ions HBeCH_2^{\oplus} ($16.3 \text{ kcal mol}^{-1}$) and HMgCH_2^{\oplus} ($38.3 \text{ kcal mol}^{-1}$) are positive (MP4SDTQ//6-31G* [29]) but considerably less than for the alkali metal substituted cations. Neglecting electron correlation and using a minimal basis set leads to much higher positive values of SE (i.e. 75 kcal mol^{-1} for HMgCH_2^{\oplus} at the RHF/STO-3G level of theory) which demonstrates the need of sufficiently large basis sets and inclusion of electron correlation to obtain reliable data. These results show that electropositive heteroatoms (Fig. 1) as σ -donors can be as effective as π -donors in stabilizing carbenium ions although the latter are more often considered. The total charge of $+0.225e$ at the carbon center in CH_3^{\oplus} is diminished to $0.096e$ and $0.117e$ in LiCH_2^{\oplus} and HBeCH_2^{\oplus} , respectively [26]. According to a Mulliken population analysis, the $2p$ - π -orbital at the carbon center remains unpopulated meaning that the charge transfer is exclusively accomplished within the σ -bond frame. Hence, LiCH_2^{\oplus} is about as stable as the $\text{Me}_3\text{C}^{\oplus}$ cation ($SE_{\text{exp}} \approx 80 \text{ kcal mol}^{-1}$) which is mainly stabilized by hyperconjugation (mechanism iii) in Scheme 1) and which was recently characterized as $\text{Me}_3\text{C}^{\oplus} \text{Sb}_2\text{F}_{11}^-$ salt by an X-ray analysis performed by Laube et al. [31].

2.2. Experimental results

Despite the large relative stabilization energies of carbenium ions with alkali or alkaline earth metal centers to our knowledge no cation of this type has been characterized in the condensed phase. Lithiated cations $\text{Li}_n\text{H}_{3-n}\text{C}^{\oplus}$ have been observed and investigated in the gas phase [32]. Only the generation of otherwise strongly stabilized lithiated carbenium ions like the cyclopropylium ion **1** were described (Scheme 2) [33] (Calculations on $\text{C}_3\text{Li}^{\oplus}$ proved this system to be particularly stable [28].)

In principle, carbenium ions with Li, Na and Mg centers may be prepared from carbenes R_2C , and a metal salt with an anion of low nucleophilicity [34] (for computation of this reaction see Ref. [26]). Although several stable carbenes [35–37] became known in the last few years this approach to α -metallated carbenium ions was not yet seriously investigated. However, Arduengo III et al. reported related complexes **2** of cyclic delocalized carbenes with Cu^{\oplus} , Ag^{\oplus} and Au^{\oplus} ions [38] as well as with zinc and magnesium alkyls **3** and **4** [39] (Scheme 2).

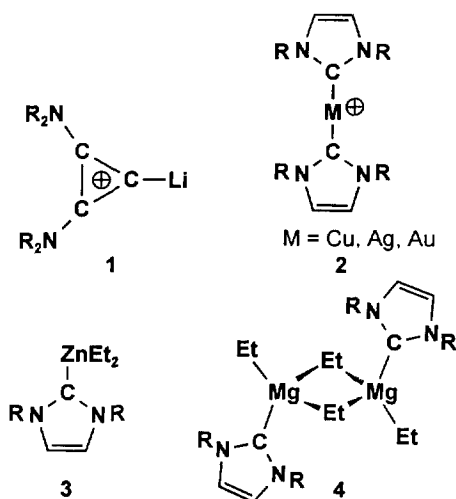

Scheme 2.

3. Carbenium ions stabilized by heteroatoms from group 13 (B, Al)

3.1. Quantum mechanical calculations

While the relative stabilizing effect of metals from groups 1 and 2 is exclusively due to σ -induction by the electropositive centers in the α -position (Fig. 1), boryl groups R_2B , may stabilize carbenium ions additionally by hyperconjugation via the $\text{R}-\text{B}$ bonds [26,29,40]. This is nicely documented by comparing the stabilization

energies SE (Eq. (1) of the conformational isomers of the cation $H_2BCH_2^{\oplus}$ in planar form **A** ($SE=2.7 \text{ kcal mol}^{-1}$) and non-planar form **B** ($SE=27.4 \text{ kcal mol}^{-1}$) [29]. In the latter, the H_2B moiety is perpendicularly orientated to the CH_2 moiety and this form is about 25 kcal mol^{-1} more stabilized (Scheme 3). Clearly, hyperconjugation contributes more to SE than σ -donation in this cation.

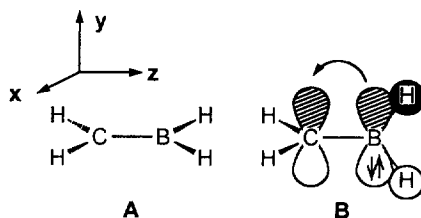

Scheme 3.

While in planar form **A** the stabilizing effect is dominated by σ -charge transfer from the electropositive boron center to the carbon center ($\approx 0.4e$), hyperconjugation of the occupied $\pi(BH_2)$ orbital leads to a population of the unfilled $2p(\pi)$ -orbital at the carbon center ($\approx 0.09e$) in form **B** in addition to σ -charge transfer ($\approx 0.33e$) [26]. [Note that there is a second hyperconjugative interaction between the filled $\pi(CH_2)$ -orbital composed from $2p_x$ carbon and $1s$ hydrogen functions and unfilled $2p_x$ orbitals at boron which leads to additional B–C bond shortening in **B** (1.562 \AA vs 1.692 \AA in **A**)]. Not unexpected, the importance of hyperconjugative interaction decreases with increasing principal quantum number j of the heteroatom. Hence, $H_2AlCH_2^{\oplus}$ in form **B** ($SE=27.4 \text{ kcal mol}^{-1}$) is only about 6 kcal mol^{-1} more stable than in its planar form **A** ($SE=21.8 \text{ kcal mol}^{-1}$) [29].

3.2. Experimental results

We are not aware of a report of the direct spectroscopic observation or even isolation of boryl- or similar substituted carbenium ions in the condensed phase. Ions like H_4CB^{\oplus} are formed in the gas phase upon electron impact (EI) on Me_3B [41]. Many *neutral* compounds in which a trigonal planar coordinated carbon center is surrounded by boron centers have been described by Berndt et al. and the electronic interactions discussed for carbenium ions may be applied to these as well [42]. Again, as outlined in Scheme 4, the reaction of a stable carbene with a suitable diorganyl boron or aluminum halide in the presence of a strong Lewis acid as halide acceptor may lead to a carbenium ion (Scheme 4).

Indeed, this approach was tested by Bertrand et al. who studied the interaction of stable phosphanyl carbenes **5** with group 13 compounds [43]. The reaction of **5** with Me_2BF , $B(OMe)_3$, $AlMe_3$, $GaMe_3$ or $InMe_3$ led to rearranged neutral products **6** which may be regarded as R_2X ($X=B-In$) substituted phosphorus ylides. The X–C bond length data and the orientation of the molecular fragments around these bonds, which deviate despite the bulky substituents only by about $30\text{--}40^\circ$ from co-planarity, allow the assumption of partial $X=C$ double bonds. The neutral

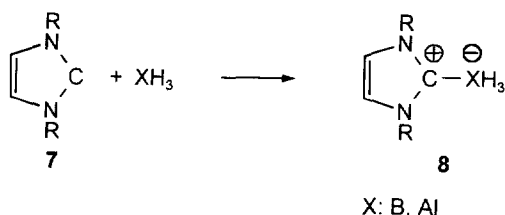
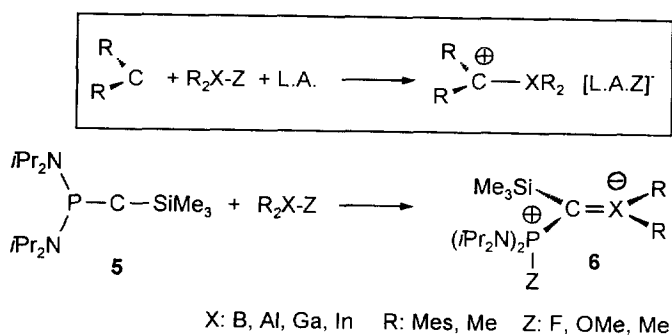

Scheme 4.

adducts of the cyclic delocalized carbenes **7** with BH_3 or AlH_3 were characterized as well [44]. However, cationic species were never synthesized from these precursors and are still unknown.

4. Carbenium ions stabilized by elements of group 14

4.1. Quantum mechanical calculations

The effect of α -silyl groups on the reactivity and stability of carbenium ions is a long standing subject of interest and debate [45]. The first *ab initio* investigation of the isodesmic reaction (2) in 1974 on the stability of $\text{H}_3\text{SiCH}_2^{\oplus}$ in comparison to $\text{H}_3\text{CCH}_2^{\oplus}$ found that a silyl group is somewhat less stabilizing than a methyl group.

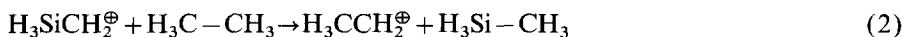

This result was inverted three years later [26] and the α -effect of the silyl group was thought to render the $\text{H}_3\text{SiCH}_2^{\oplus}$ ion more stable by 4 kcal mol^{-1} . This conclusion was based on calculations performed at the RHF/STO-3G level and the stabilization was attributed mainly to σ -charge transfer (see Fig. 1). However, larger basis sets (e.g. 6-31G*) together with electron correlation correction using Møller–Plesset perturbation theory up to the fourth order (MP4) demonstrated that indeed a methyl group stabilizes a carbenium ion considerably more ($\Delta SE \approx 17 \text{ kcal mol}^{-1}$) than a silyl group [29,45,46]. The explanation can be given in terms of the MO

language by better hyperconjugative interaction of the occupied $\pi(\text{CH}_3)$ orbital with the unfilled $2p(\pi)$ -orbital at the carbon center. The corresponding $\pi(\text{SiH}_3)$ orbital lies much higher in energy and hence interacts only weakly with $2p(\pi)$ -C. In terms of the resonance structures shown to illustrate hyperconjugation ii) in Scheme 1, it can be concluded that the no-bond resonance structure $[\text{H}^\oplus\text{H}_2\text{Si}=\text{CH}_2] \leftrightarrow [\text{H}_3\text{Si}-\text{CH}_2^\oplus]$ contributes less to the electronic ground state of α -silyl carbenium ions while the contrary holds for the $\text{H}_3\text{C}-\text{CH}_2^\oplus$ cation. The latter is almost exclusively stabilized by hyperconjugation. However, σ -charge transfer from the electropositive H_3Si group stabilizes $\text{H}_3\text{SiCH}_2^\oplus$ over $\text{H}_3\text{C}^\oplus$ by about 18 kcal mol^{-1} . If the demand for hyperconjugative stabilization by groups in the α -position to a carbenium center is largely diminished as in the case of vinyl cations $\text{H}_2\text{C}=\text{C}^\oplus-\text{CH}_3$ and $\text{H}_2\text{C}=\text{C}^\oplus-\text{SiH}_3$ the stabilizing effect of both groups is calculated to be the same [46].

4.2. Experimental results

Most of the early experimental work about α -silyl substituted carbenium ions stems from kinetic investigations of solvolysis reactions [45]. From these studies, it was generally concluded that silyl groups have a destabilizing α -effect when compared to the analogous hydrocarbon system. For example, it was found that $\text{Me}_3\text{C}(\text{CH}_3)_2\text{C}-\text{Br}$ was hydrolyzed 38 000 times faster than $\text{Me}_3\text{Si}(\text{CH}_3)_2\text{C}-\text{Br}$ in aqueous ethanol [47]. Exceptions from these observations could be explained by the fact that different reaction mechanisms may be valid in which no (solvated) carbenium ions are formed in the case of the silicon compounds [48]. If α -silyl substituted carbenium ions **10** are generated from the precursor **9** they rearrange via a

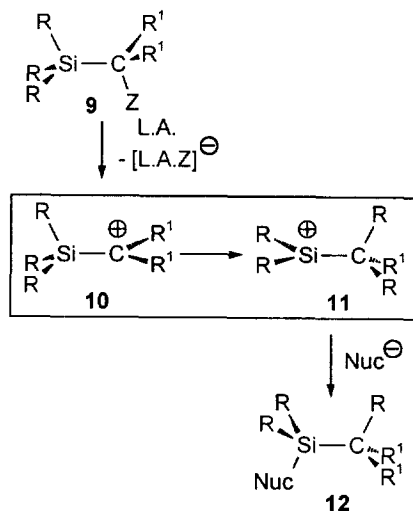

Scheme 5.

1,2-migration of one substituent on the silyl group to the carbenium center to form thermodynamically more stable silylenium ions **11** (Scheme 5).

The intermediacy of a silylenium ion **11** in the course of this reaction is commonly accepted and products **12** derived from them are taken as an indication that a reaction proceeded by an ionic pathway [45]. Ions **11** ($R = \text{Me}$, $R^1 = \text{Ph}$) can be detected by NMR spectroscopy at low temperatures (-78°C) under “long-lived stable ion conditions” (i.e. $\text{HSO}_3\text{F}/\text{SO}_2\text{ClF}$) [49]. They show a ^{13}C resonance signal for the central carbon atom at δ 259 which is considerably downfield shifted (30 and 60 ppm, respectively) compared to signals observed for the corresponding $\text{Ph}_2\text{CCH}_3^\oplus$ and $\text{Ph}_2\text{CH}^\oplus$ carbenium ions. At higher temperatures all α -silyl substituted carbenium ions undergo the 1,2-migration shown in Scheme 5 and there is to our knowledge no species known which is persistent at room temperature in solution or solid state. Soderquist et al. investigated the hydrolysis of α -substituted vinylmethylethers, $\text{H}_2\text{C}=\text{C}(\text{OMe})\text{XMe}_3$ ($\text{X} = \text{H}, \text{C}, \text{Si}, \text{Ge}, \text{Sn}$). As intermediates, the carbenium ions $\text{H}_3\text{C}-\text{C}(\text{OMe})\text{XMe}_3^\oplus$ were assumed and based on the observed reaction rates the stability ordering $\text{C} > \text{Sn} > \text{Ge} > \text{Si} > \text{H}$ was given [50].

5. Carbenium ions stabilized by heteroatoms from group 15 (N, P, As, Sb)

5.1. Quantum mechanical calculations

Nitrogen substituted carbenium ions like the iminium ions $\text{R}_2\text{NCR}_2^\oplus$ (**13**), amidinium ions $(\text{R}_2\text{N})_2\text{CR}^\oplus$ (**14**) and guanidinium ions $(\text{R}_2\text{N})_3\text{C}^\oplus$ (**15**), are long known, “rock stable” cations and systems containing these structural motifs have found widespread use in synthetic chemistry [9,51,52], biological processes and molecular material sciences [53]. The highly stabilizing ability of the H_2N -group in planar $\text{H}_2\text{NCH}_2^\oplus$ is reflected by all calculations on various levels of theory using isodesmic reaction (Eq. (1)) ($\text{X} = \text{NH}_2$; $SE \approx 95 \text{ kcal mol}^{-1}$) [9,29,54–59]. This is in excellent agreement with the experimentally determined value ($SE = 95\text{--}97 \text{ kcal mol}^{-1}$) [60]. While the σ -electron donating ability of all electropositive heteroatoms in the carbenium ions discussed so far is evident simply by regarding the electronegativities shown in Fig. 1, the origin of the stabilization energy in nitrogen substituted carbenium ions is due to π -donation of the nitrogen lone pair into the formally unfilled $2p(\pi)$ -orbital of the carbon center. The calculated π -donating effect thereby overcompensates the σ -attracting effect and the overall effect is to diminish the formal +1 charge on the carbon center (*vide infra*). Iminium ions **13** may be therefore described as polar double bonded systems $\text{H}_2\text{N}=\text{CH}_2$ justified experimentally by the planar molecular form and the high rotation barrier ($\approx 78 \text{ kcal mol}^{-1}$) around the $\text{C}=\text{N}$ -bond [9,29,57]. Note, that according to calculations [57] the $\text{C}=\text{N}$ double bond in the iminium ion $\text{H}_2\text{N}=\text{CH}_2^\oplus$ (1.262 Å) is slightly longer but considerably stronger (about 57 kcal mol^{-1} by experiment) than the $\text{C}=\text{N}$ bond in the corresponding imine $\text{HN}=\text{CH}_2^\oplus$ (1.248 Å) in contrast to common expectations. Using high level *ab initio* calculations, Frenking et al. [58] analyzed in detail the electronic structure of **13**, **14** and **15** (Scheme 6).

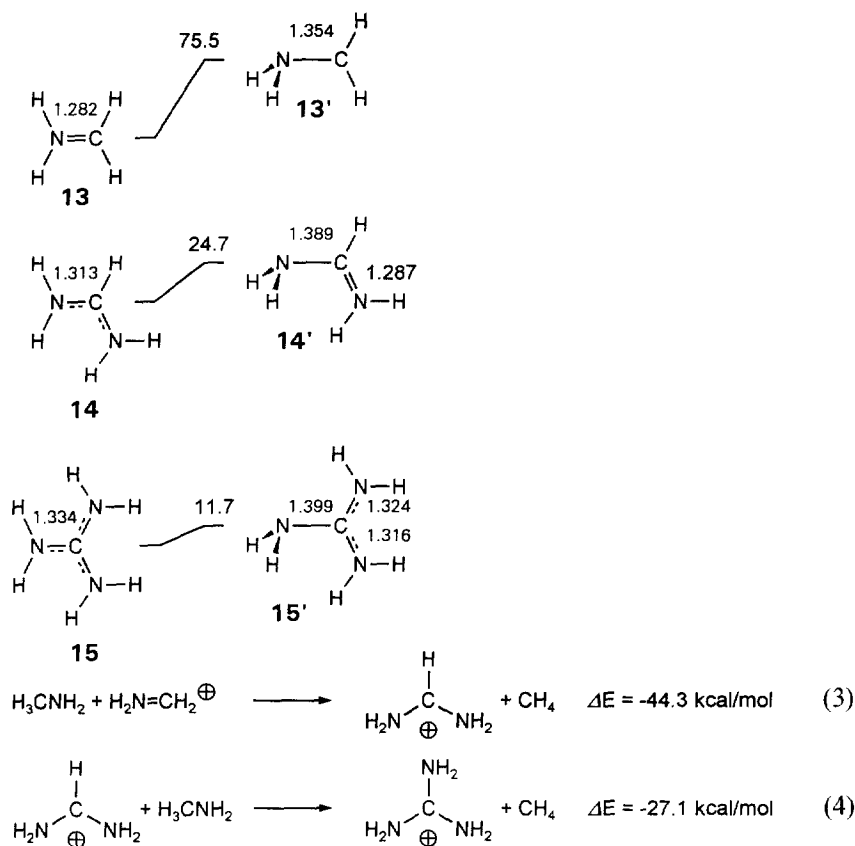

Scheme 6. All values are calculated at MP2/6-31**/MP2/6-31G* level [58]; rotation barriers and C–N bond lengths are given in kcal mol⁻¹ and Å, respectively.

Despite the charge-transfer by π -donation from the nitrogen to the carbon center the latter remains positively charged. The positive charge on the carbon atom calculated by the Natural Population Analysis [61] increases roughly by $+0.3e$ per each additional NH_2 group (Scheme 6). The number of π -electrons incorporated by each amino substituent is augmented gradually by two electrons in going from **13** (2π -electron system) to **14** (4π -system) to **15** (6π -system). Based on calculated reaction energies of isodesmic reactions (3) and (4) shown in Scheme 6 it was concluded that there is no particular extra stabilization of the guanidinium ion **15** due to Y-aromaticity. The amidinium ion **14** is about 44 kcal mol^{-1} more stable than **13** but **15** gains only about 30 kcal mol^{-1} when the remaining hydrogen in **14** is replaced by a third NH_2 group. However, conjugation of the lone pairs at the nitrogen centers with the formally $2p(\pi)$ -orbital is important in all three systems. This effect is strongest in **13** evidenced by its high rotation barrier (78 kcal mol^{-1}) while in **14** (26 kcal mol^{-1}) and **15** (12 kcal mol^{-1}) considerably lower energies are

required for rotation of *one* amino group. The nitrogen centers which are trigonal planar coordinated in the conjugated forms become pyramidalized when rotated about 90°. The C–N bond formed between the out-of-plane rotated NH₂ group and carbon center is considerably elongated in **13'**, **14'** and **15'** (see Scheme 6). The C–N bonds to the NH₂ groups remaining in plane are slightly shortened and the positive charge on the central carbon atoms in **13'**, **14'** and **15'** increases. However, it might be possible that these results change when a simultaneous rotation of *all* amino groups is considered in **14** and **15** which is more likely in substituted carbenium ions (R₂N)_nCH₃^{⊕-n} (R ≠ H). Furthermore, Gobbi and Frenking pointed out that the calculated gas phase proton affinities of ammonia (NH₃ + H[⊕] → NH₄[⊕]; 217.2 kcal mol⁻¹), imine (HN=CH₂ + H[⊕] → H₂N=CH₂[⊕]; 216.2 kcal mol⁻¹) and guanidine [HN=C(NH₂)₂ + H[⊕] → H₂N=C(NH₂)₂[⊕]; 245.1 kcal mol⁻¹] do not differ largely and do not explain the unusual high basicity of guanidine in solution. Other factors like formation of stable aggregates *via* strong hydrogen bonding must be responsible for this phenomenon (*vide supra*).

How does the π-donor ability of heteroatoms of the higher periods compare with the one from the second period? This question is tightly connected with the notion that the elements of the higher periods form weak π-bonds. In their experimental study performed in 1965, Taft et al. mentioned the unusual large stabilizing effect of π-donating heteroatoms from the third or higher period on carbenium ions which is in conflict with any aromatic σ-scale [60]. They found indeed the reverse order of the expected *SE*'s for some heteroatoms, i.e. I > Br > Cl > F and S > O in the gas phase. For the Me₂PCH₂[⊕] ion (79 kcal mol⁻¹) a smaller but still considerable stabilization was found as compared to the Me₂NCH₂[⊕] ion (106 kcal mol⁻¹). Ten years later Bernardi, Csizmadia and Epiotis investigated the π-donating ability of heteroatoms from the third period versus those from the second period by *ab initio* SCF methods using the 4-31G basis set [54]. They demonstrated that the *assumption that a second period heteroatom (N, F) is a better π-electron donor than a heteroatom from a higher period (j > 2) which was based on assumed overlap integrals is false*. These integrals should be considered solely as *proportionality constants* which have *a priori* no meaning when not applied to quantum mechanical terms describing exchange interactions. Generally, in perturbation molecular orbital (PMO) language the expression (5) may be used to approximate the electron transfer from donor center D to acceptor center A which applied to carbenium ions means transfer of intramolecular π-electron density from the heteroatom X (=D) to acceptor fragment CH₂[⊕] (=A):

$$q = 2K^2 S_{(DA)}^2 [\Delta E^2]^{-1} \quad (5)$$

Here, *q* is the electron transferred from D to A by mixing the vacant 2p(π) orbital φ_A on the carbon atom with the np(π) orbital φ_D of the heteroatom. *K* is a constant, *S*_(DA) is the overlap integral and Δ*E* is the energy gap between the acceptor and donator orbital. The energy gap can be approximated by Δ*E* = *E*^{LUMO}(CH₃[⊕]) – *IP*(XH_n) where *E*^{LUMO}(CH₃[⊕]) corresponds to the energy of the vacant 2p(π) orbital of CH₃[⊕] which can be quantum mechanically calculated. The

potential $IP(XH_n)$ corresponds to the first vertical ionization potential of the molecule XH_n ($X=F, Cl, n=1$; $X=O, S, n=2$; $X=N, P, n=3$) which serves as an approximate experimental measure of the donor orbital energy ϕ_D . It becomes clear that any element from a higher period ($j>2$) will always favor electron transfer q due to a considerably lower IP and hence small ΔE gap. The calculated differences in the overlap integrals $S_{(DA)}$ when compared within a main group are small and differ considerably only along a row (i.e. $S_{(NC)}=0.2596$; $S_{(PC)}=0.2442$; $S_{(OC)}=0.2169$; $S_{(SC)}=0.2120$; $S_{(FC)}=0.1680$; $S_{(ClC)}=0.1802$ using SCF-STO atomic orbitals [54]). Note that even the overlap integrals favor Cl and S as π -donors over their lighter congeners F and O. The assumption that smaller overlap integrals are responsible for weak π -bonds when π -bonding between centers from the higher periods is compared with π -bonding among second period heteroatoms was criticized repeatedly by theoreticians [26,54,61,62]. Therefore, heteroelements out of the higher periods should stabilize formally electron deficient centers (i.e. C^\oplus , **B**) not less, but more efficiently than second period elements if only π - and σ -donation (note that all heteroatoms $j>2$ are more electropositive than carbon, Fig. 1) are accounted for as stabilizing electronic effects.

Calculations on methylenephosphonium ions $R_2P=CR_2^\oplus$, were performed several times and the results are summarized in Scheme 7 [29,30,54–56,59,63–66]. The stabilization energy SE calculated according to isodesmic Eq. (1) ($X=PH_2$; see also Scheme 8) is about 63 kcal mol^{-1} for **16a** in reasonable accordance with the experimental value (79 kcal mol^{-1}) obtained for **16c** [60]. This SE value is 37 kcal mol^{-1} lower than the SE calculated for iminium ion $H_2N=CH_2^\oplus$ **13** at the same level of theory [29].

All calculations performed at various levels predict a planar structure for $H_2P=CH_2^\oplus$ **16a** and its derivatives **16b–f**. The $P=C$ bond ($1.62\text{--}1.638 \text{ \AA}$) is considerably shortened (by about 9%) when compared to a $P-C$ single bond (1.85 \AA). The energy barrier to rotation amounts to about $31\text{--}47 \text{ kcal mol}^{-1}$ which indicates a high double bond character of the carbon–phosphorus bond in phosphanyl substituted carbenium ions as well as compared to iminium ions **13**. However, a frequency analysis of **16d** revealed a normal mode of very low energy describing the distortion from C_{2v} to C_s symmetry with a pyramidal phosphorus center [65]. Note that the phosphorus center of isoelectronic phosphino boranes **18** is pyramidalized in the ground state conformation which was found experimentally when substituents R and R^1 have a low steric demand [67]. The $P=C$ bond in **16a–f** may be therefore described as a “soft double bond”. Exceptions are the P -amino substituted ions **16g** and **16h** which have, in spite of the shortest $P-C$ bonds, the lowest rotation barriers [65]. A considerable twist of 15° around the $P-C$ bond occurs already in the ground state conformation of **16g** and **16h** which seems to be a typical characteristic of Y -conjugated molecules. Twisted conformations were also found as energetic minima for isovalence electronic molecules like $(H_2N)_3C^\oplus$ (**15**; *vide supra*) or anionic $(H_2C)_3P^-$ [68] and $(H_2C)_3C^{2-}$ [69]. Although rotation barriers are commonly considered to be a measure of the π -bond strength in double bond systems, in methylene phosphonium ions they correspond only to the lower limit of the π -bond strength. Optimized structures of **16'** (RHF-level) in which the H_2P group is rotated

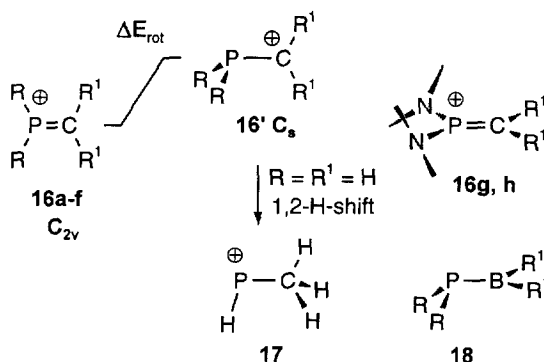

	R	R	R ¹	R ¹	q(P)	q(C)	P-C[Å]	ΔE_{rot}^a	References
16a	H	H	H	H	+0.7	-0.2	1.62	31.4-47.5	29,30,54,55,59,63,64,65
16b	H	Me	H	H	-	-	-	-	63
16c	Me	Me	H	H	+1.0	-0.2	-	-	80
16d	Me	Me	Me	Me	+0.86	-0.12	1.642	-	65
16e	H	H	SiH ₃	SiH ₃	+0.7	-0.7	1.619	33.8 ^b	65
16f	Me	Me	H	SiH ₃	+1.0	-0.5	-	-	80
16g	H ₂ N	H ₂ N	H	H	+1.3	-0.5	1.598	-	65
16h	H ₂ N	H ₂ N	SiH ₃	SiH ₃	+1.4	-1.0	1.593	20.0 ^b	65

a) ΔE_{rot} in kcal mol⁻¹; b) assuming C_{2v} symmetry for the rotated form.

Scheme 7.

by 90° show C_s symmetry and have pyramidalized phosphorus centers [63,64]. The energy release upon pyramidalization diminishes the P=C- π -bond energy. The inversion barrier in methylphosphane, H₃C-PH₂, amounts to ≈ 36 kcal mol⁻¹ [64] and this energy has to be compensated for when **16a** is formed upon hydride abstraction. If this planarization energy is taken into account and added to the methyl stabilization energy *SE* mentioned above, a H₂P group stabilizes a carbenium ion to the same extent as a H₂N group for which the planarization energy amounts to only a few kilocalories per mole [55,59,64]. Furthermore, symmetry unrestricted optimization of the twisted conformation **16'** at RHF/6-31G** level gave the rearranged phosphonium ion H₃C-PH⁺ (**17**) [30] which in its singlet ground state is about 14 kcal mol⁻¹ higher in energy than H₂P=CH₂⁺ (**16**) [63]. Schleyer et al. have recently broadly extended earlier investigations and calculated among other species H₂X-CH₂⁺ where X=N, P, As, Sb [59]. They found indeed that all pnictogen centers stabilize a carbenium ion with respect to CH₃⁺ by the same amount of π -donation (95 kcal mol⁻¹) and it is the increasing inversion barrier [4.23 (N)→48.4 (Sb) kcal mol⁻¹] which has to be overcome in this series of compounds which diminishes *SE* from 93.9 kcal mol⁻¹ (N) to 45.2 kcal mol⁻¹ (Sb) [55,59].

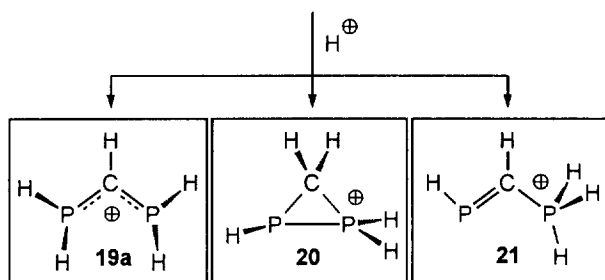
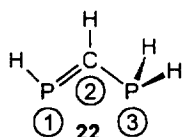
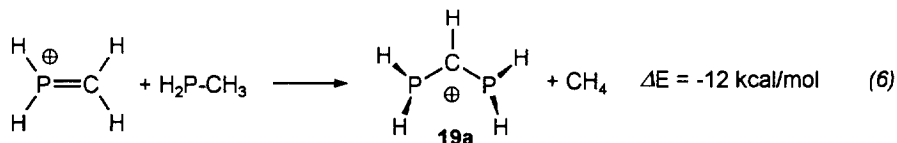
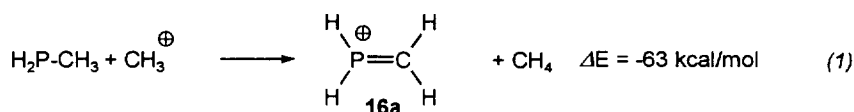

	186.28	205.30	200.26	[kcal/mol]
PA				
$\Delta E(\text{rel})$	21.8	0.0	6.4	[kcal/mol]

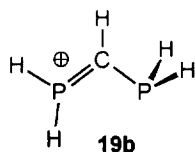

$\Delta E(\text{rel}) = 26.1$

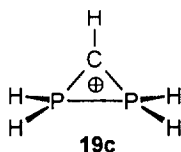

$\Delta E(\text{rel}) = 49.3$

P-C bond lengths in **19a**, **19b**, **19c**, **20**, and **21**

	P1-C2 [Å]	P3-C2 [Å]	P1-C2-P3 [°]
19a	1.722	1.722	130.5
19b	1.644	1.866	120.0
19c	1.697	1.697	76.5
20	1.892	1.799	71.7
21	1.680	1.772	119.2

Scheme 8.

Furthermore, it is instructive to compare the calculated total charges residing on the H_2P and CH_2 fragments in $\text{H}_2\text{P}=\text{CH}_2^\oplus$ (**16a**) and compare these with the total charge distribution in $\text{H}_2\text{N}=\text{CH}_2^\oplus$ (**13**). In **16a** the H_2P fragment bears a considerable positive charge and the CH_2 fragment a negative charge while in **13** the CH_2 unit is positively charged and the H_2N fragment negatively. The polarization of the $\text{P}=\text{C}$ bond in methylenephosphonium ions **16** by various substituents at the phosphorus and/or carbon center can be deduced from the calculated partial charges q on phosphorus and carbon (Scheme 7). Note that C-silyl substitution polarizes the $\text{P}=\text{C}$ bond such that additional negative charge is accumulated on the carbon center [compare $q(\text{C})$: **16a** < **16e**, **16c** < **16f**; and **16g** < **16h**].

Replacing one hydrogen atom in iminium ion **13** by an additional NH_2 group further stabilizes the amidinium ion **14** by an extra 44 kcal mol⁻¹. How does a second PH_2 group influence the stability of the methylene(bisphosphonium) ion **19a**? Following the work of Gobbi and Frenking we calculated the reaction energy of isodesmic reaction (6) shown in Scheme 8 at the MP2/6-31G* level [70].

We found that a second PH_2 group stabilizes cation **19a** only about 12 kcal mol⁻¹ over **16a** which corresponds to about one fifth of the stabilization energy found for **16a**. Note that in optimized C_2 symmetric **19a** both phosphorus centers are pyramidalized and the $\text{P}-\text{C}$ bonds are considerably elongated (1.722 Å) in comparison to **16a** (1.638 Å). In contrast, the nitrogen substituted carbenium ions **13** and **14** both have planar NH_2 groups and the $\text{C}-\text{N}$ bond lengths differ only very little (Scheme 6). Obviously, the introduction of two electropositive H_2P groups diminishes the formal electron demand to an extent which makes the carbon center insufficiently electrophilic to cause planarization at the phosphorus centers and maximize π -donation. Alternatively, it may be reasoned that two lone pairs in α -position to the partially occupied $2p(\pi)$ -orbital of the negatively charged carbon center lead to an unfavorable 3-center-6 π -electron type interaction which causes $\text{P}-\text{C}$ bond elongation and pyramidalization at phosphorus. This result led us to search for further, possibly more stable isomers of **19a**. Indeed, we found the cyclic C_1 symmetric compound **20** to be the global minimum on the CP_2H_5 hypersurface, which is 21.9 kcal mol⁻¹ more stable than **19a**. Being only 6.4 kcal mol⁻¹ higher in energy than **20**, but still 15.5 kcal mol⁻¹ more stable than **19a**, the phosphonio substituted phosphalkene **21** was located. A very similar structure has already been synthesized and characterized by an X-ray analysis [71]. In both compounds **20** and **21**, a destabilizing interaction of phosphorus lone pairs with the negatively charged carbon center does not occur. Geometry optimization of a form of **19a** in which one PH_2 group was rotated by 90° led to **19b** as a further minimum which is 4.2 kcal mol⁻¹ less stable than **19a**. Compound **19b** can be best described as a phosphanyl substituted methylenephosphonium ion with one short and one long $\text{P}-\text{C}$ bond including the planar and pyramidal phosphorus center, respectively. When both PH_2 groups are rotated about 90° in **19**, geometry optimization led to the cyclic ion **19c** with C_{2v} symmetry. This is the least stable isomer (49.3 kcal mol⁻¹ less stable than **20**) due to the high ring strain caused by two PH_2 groups and the CH unit. Note that ring strain is much smaller in **20** because of the presence of one PH and one CH_2 group as is expected from the low ring strain in cyclopropane

$(\text{CH}_2)_3$ and phosphirane $\text{HP}(\text{CH}_2)_2$. The three different isomers **19**, **20** and **21** may be obtained by protonation of the P1, C2 and P3 sites of a neutral phosphanyl substituted phosphalkene like **22** as a precursor (Scheme 8). The energetically favored protonation of the C-site is in contrast to the energetically preferred protonation of phosphalkene $\text{HP}=\text{CH}_2$ which is protonated preferentially at the P-site to yield **16a** [63]. These results demonstrate nicely that not only structurally related compounds containing centers from the higher periods may be electronically very different, but that completely different isomers may be found, when compared to those containing centers from the second period.

5.2. Experimental results

5.2.1. Nitrogen substituted carbenium ions

Since the basic chemistry of iminium, amidinium and guanidinium ions is already extensively reviewed we will only refer to two recent examples where nitrogen substituted carbenium ions play a crucial functional role. As already mentioned above, the formation constants for amidinium $(\text{RHN})_2\text{CR}^{\oplus}$ and guanidinium ions $(\text{RHN})_2(\text{R}'_2\text{N})\text{C}^{\oplus}$ in solution by protonation of the neutral precursors are surprisingly high. These ions form very stable cation/anion aggregates *via* hydrogen bridges, which make the function of guanidinium ions as anion receptors in biological systems plausible [72]. Recently, von Kiedrowski et al. used these principles to develop an artificial minimal self-replicating system [73] (Scheme 9).

Apart from the non-catalytic reaction, the imine **A–B** is formed from the aniline **A** and the aldehyde **B** in an additional autocatalytical reaction channel because the higher the concentration of the complex **A–B** at the beginning of the reaction the faster is its formation. This observation can be explained if the imine **A–B** serves as a matrix for its self-replication and formation of the ternary complex $[(\text{A–B})\text{AB}]$ in which the reactants are pre-organized in close proximity. The amidinium moiety of **A–B** binds the carboxylate function of **B** while the carboxylate group in **A–B** binds the amidinium function of **A**. In the ternary complex $[(\text{A–B})\text{AB}]$ imine formation is facilitated and hence an overall enhancement of the rate is observed if the duplex $(\text{A–B})_2$ dissociates fast enough. This dissociation of duplex $(\text{A–B})_2$ liberates two molecules **A–B** which enter the autocatalytical reaction cycle. A careful iterative examination of the complex kinetic scheme revealed that in this system formation of **A–B** can be at best accelerated by a factor of 370M^{-1} .

Another example in which an amidinium group has possibly a function in a different catalytic cycle was recently proposed. To explain the enzymatic reversible hydrogenation of the tetrahydromethanopterin MP^{\oplus} which contains an amidinium functionality by a metal free bacterial hydrogenase, Berkessel and Thauer proposed the mechanism outlined in Scheme 10 [74].

The substrate **MPH** is taken up by the enzyme and fixed such that the imidazolidine ring has the envelope conformation shown. The axial hydrogen center is stereoselectively (proven by isotopic labeling studies) cleaved off under formation of MP^{\oplus} and dihydrogen. This reaction is reversible, i.e. MP^{\oplus} is taken up and hydrogenated by H_2 to yield **MPH**.

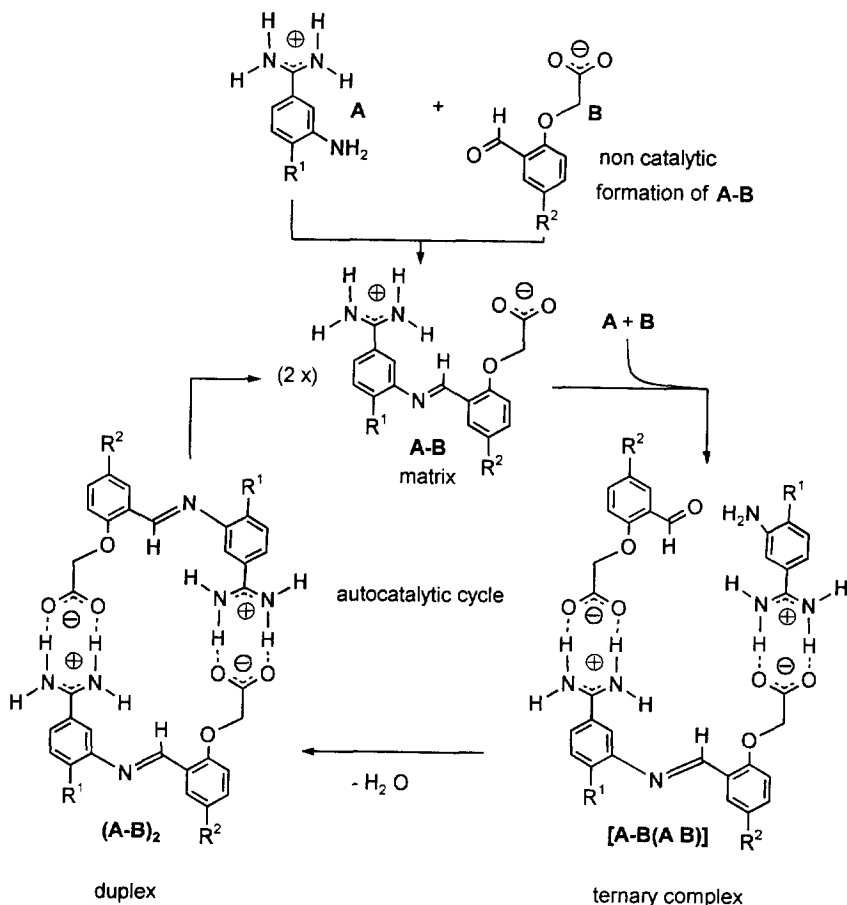

Scheme 9.

There is experimental evidence for the dehydrogenation reaction within the catalytic cycle. Guanidinium derivative TAP^{\oplus} and dihydrogen are formed when the triazaphenalene TAPH is reacted with HF_4 at $110^{\circ}C$. This irreversible reaction may be explained by the high stability of nitrogen substituted carbenium ions and the particular antiperiplanar arrangement of the C–H bond and the three non-bonding electron pairs at the nitrogen centers. Hence, a comparable reaction may take place when MPH is fixed by the enzyme in an analogous conformation and an acidic site of the enzyme protonates the C–H bond (see box in Scheme 10). Because of the high stability of trigonal planar nitrogen substituted carbenium ions, the reverse reaction, i.e. the hydrogenation of the amidinium moiety in MP^{\oplus} is much more difficult to envisage. It is therefore suggested that the enzyme not only fixes MPH in the shown folded envelope conformation but that also the nitrogen centers of the imidazolidine ring are protonated by acidic enzyme sites. This would strongly

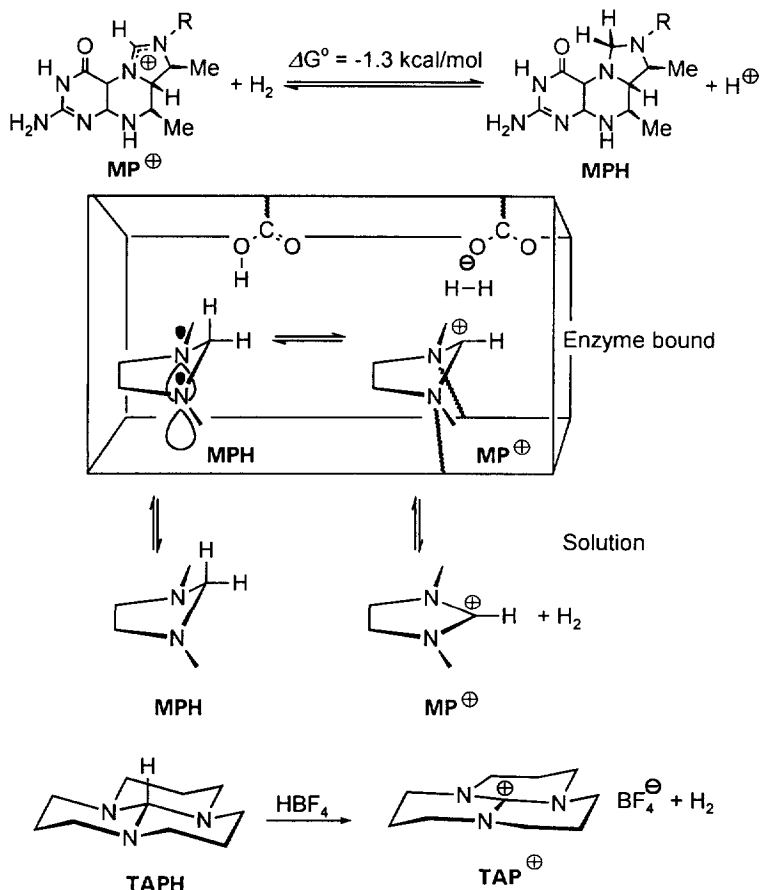

Scheme 10.

diminish conjugative stabilization of enzyme bound MP^{\oplus} and generate a highly electrophilic reaction center which may be sufficient to cleave heterolytically H_2 into H^{\oplus} and H^{-} . Indeed, the hydrogenation of the *tert.*-butyl cation, $\text{Me}_3\text{C}^{\oplus}$, by H_2 and H/D exchange in alkanes under superacidic condition are well known reactions [75,76].

5.2.2. Phosphorus substituted carbenium ions

5.2.2.1. *Synthesis of methylenephosphonium ions.* Methylenephosphonium ions **24** were postulated as intermediates in the course of alkylation reactions of methylenephosphanes (phosphaalkenes) **23** (Scheme 11) [77].

Preferential addition of an electrophile E^{\oplus} to the phosphorus center of **23** is in accord with theoretical investigations [63]. P-site protonation of $\text{HP}=\text{CH}_2$ is found

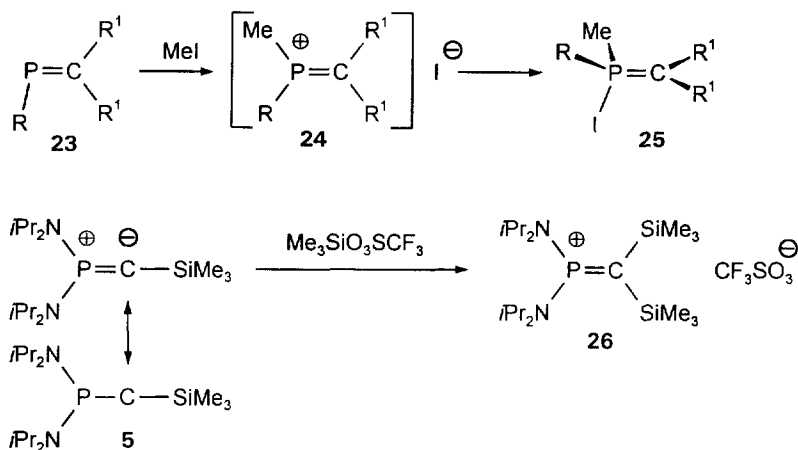

to be favored by 12–14 kcal mol⁻¹ over C-site protonation which would yield the phosphonium ion HPCH_3^{\oplus} (see **17** in Scheme 7).

This synthetic strategy, however, was not yet further investigated and the first stable methylenephosphonium ion **26** was prepared by an “inverse” approach in which an electrophile was added to the carbon center of the nucleophilic carbene **5** (Scheme 11; see also Scheme 4) [78]. An X-ray structure analysis of **26** proved the trigonal planar coordination spheres of the phosphorus and carbon centers; there is no close contact between the triflate anion CF_3SO_3^- and the cation in the solid state or in solution. The carbon phosphorus bond length (1.62 Å) is very short in comparison to P=C double bond distances found generally in methylenephosphanes (1.68–1.72 Å). In view of the strong twist of about 60° around the P=C bond in **26** which diminishes $\pi(\text{P})-\pi(\text{C})$ overlap this observation is surprising at first glance. However, as pointed out in Section 4.1 the π -system of **26** is comparable to other Y-shaped 6 π -systems and the enhanced charge separation $\text{P}^{\delta+}=\text{C}^{\delta-}$ (see **16g,h** in Scheme 7) leads to strong electrostatic attractions and bond shortening. Dialkylphosphanyl substituted methylene phosphonium ions **28a–f** can be prepared in high yields from the corresponding P-chloro substituted phosphorus ylides **27a–f** and AlCl_3 as a halide abstracting reagent (Scheme 12) [78–80]. The methylenephosphonium salts are obtained as colorless or slightly yellow crystals or viscous oils which are highly sensitive towards moisture.

The ylides **27** were prepared from phosphanes $t\text{Bu}_2\text{P}-\text{CHR}^1\text{R}^2$ which bear a hydrogen center (or Me_3Si group) in an α -position and CCl_4 [81]. The reaction proceeds with extrusion of CHCl_3 (or $\text{Me}_3\text{SiCCl}_3$) and is rather limited concerning the substitution pattern at the P-site (*tert*-alkyl, amino and alkoxy groups). It turned out to be impossible to prepare the methylenephosphonium salt **26** using the corresponding ylide $(i\text{Pr}_2\text{N})_2\text{CIP}=\text{C}(\text{SiMe}_3)_2$ as precursor. Instead, the P-chloro substituted phosphonium salt $[(i\text{Pr}_2\text{N})_2\text{CIP}-\text{CH}(\text{SiMe}_3)_2]^{\oplus} \text{AlCl}_4^-$ was obtained upon

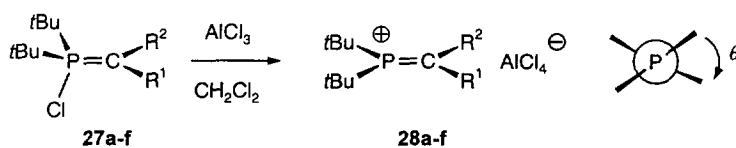

	R ¹	R ²	δ 31P	δ 13C	P=C [Å]	θ [°]
28a	Ph	Ph	183.5	178.1	1.683	20
28b	Ph	4-MeC ₆ H ₄	179.1	179.2	-	-
28c	Ph	3-MeC ₆ H ₄	179.7	179.7	-	-
28d	Ph	2-MeC ₆ H ₄	184.7	180.6	1.680	22
28e	H	SiMe ₃	245.4	149.6	1.69	11
28f	SiMe ₃	SiMe ₃	258.7	178.8	-	-
26	(iPr ₂ N) ₂ P=C(SiMe ₃) ₂		130.8	76.5	1.620	60

Scheme 12.

reaction with AlCl₃. Because the CH₂Cl₂/AlCl₃ system is a strong one-electron oxidant for molecules with a vertical ionization potential below 8 eV, this salt is formed presumably *via* the radical cation of the ylide, [(iPr₂N)₂CIP-C(SiMe₃)₂][⊕]·. Hence, the synthetic approach outlined in Scheme 12 is so far limited to *tert.*-butyl substituted methylenephosphonium salts. The structures of **28a**, **28d** and **28e** were determined by X-ray crystal diffraction. The P=C distances (1.68 Å) are about 0.06 Å longer than in the P-amino substituted derivative **26** although the twist angles θ are considerably smaller (11–22°). This observation stresses the importance of considering carefully Coulomb interactions when multiple bonding between heavier main group element centers is discussed on the basis of bond lengths data. In all cases the phosphorus centers have a trigonal planar coordination sphere. In comparison to the tritylium ion, Ph₃C[⊕], in which the three phenyl groups are rotated by 30° out of the central plane, the phenyl groups in **28a**, **d** are even more steeply orientated (ca. 55°) such that conjugation with the aryl groups is largely diminished and does not contribute significantly to the electronic stabilization of these carbenium ions.

Since the *tert.*-butyl groups of the unsymmetrical C-substituted cations of **28b–d** are inequivalent, an experimental estimate of >20 kcal mol⁻¹ could be obtained for the P=C rotation barrier. In the ³¹P and ¹³C NMR spectra of **26** and **28a–f** comparatively low field (high frequency) shifted resonances for the nuclei of the P=C unit are observed (Scheme 12) which lie in the typical range of P=C double bonded systems. The ¹³C resonances are more shielded in comparison to other diarylsubstituted carbenium ions (Ph₂CH[⊕]: δ 200.6; Ph₂CMe[⊕]: δ 229.2; Ph₂CSiMe₃[⊕]: δ 259 ppm [82]).

5.2.2.2. *Reactivity of methylenephosphonium ions.* Because methylenephosphonium salts are a rather new class of unsaturated organophosphorus compounds their reactivity has not been reviewed elsewhere to date and will be described here briefly in comparison with the well-established reactivity of iminium ions. The polarity of the $P^{\delta+}=C^{\delta-}$ bond is evident in reactions of methylenephosphonium salts with simple nucleophiles like F^- , Cl^- or OR^- (Scheme 13). In these reactions the phosphorus center is attacked while in iminium ions the nucleophile adds to the carbon center [83].

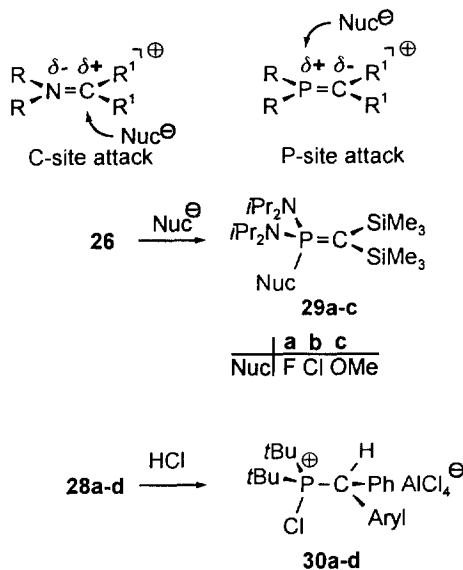

Scheme 13.

In a quantitative reaction the phosphorus ylides **29a–c** are obtained. The dialkyl-substituted methylenephosphonium salts **28a–d** react with HCl and as expected the P-chloro substituted phosphonium salts **30a–d** were isolated. However, attempts to dehydrochlorinate **30a–d** with an amine base to prepare in return methylenephosphonium salts **28a–d**, failed [84].

In order to demonstrate the $P=C$ double bond character of methylenephosphonium ions, these were reacted with dienes. While the P-diamino substituted methylenephosphonium salt **26** is unreactive, the C-silylated dialkyl methylenephosphonium ions **28e,f** react exothermically with electron rich conjugated hydrocarbon π -systems. The C-monosilylated derivative **28e** yields the [2+4] cycloadducts **31** and **32**, **33** exclusively upon addition of 2,3-dimethylbutadiene or 6,6-dimethylfulvalene, respectively (Scheme 14) [78,85].

The isomers **32** and **33** are obtained in a 1:1 ratio and **32** was characterized by an X-ray analysis. The reaction between **28e** and anthracene proceeds slower but again yields the polycyclic phosphonium salt **34** in high yield [85]. When C-disilylated methylenephosphonium salt **28f** is reacted with isoprene at low temperatures, the

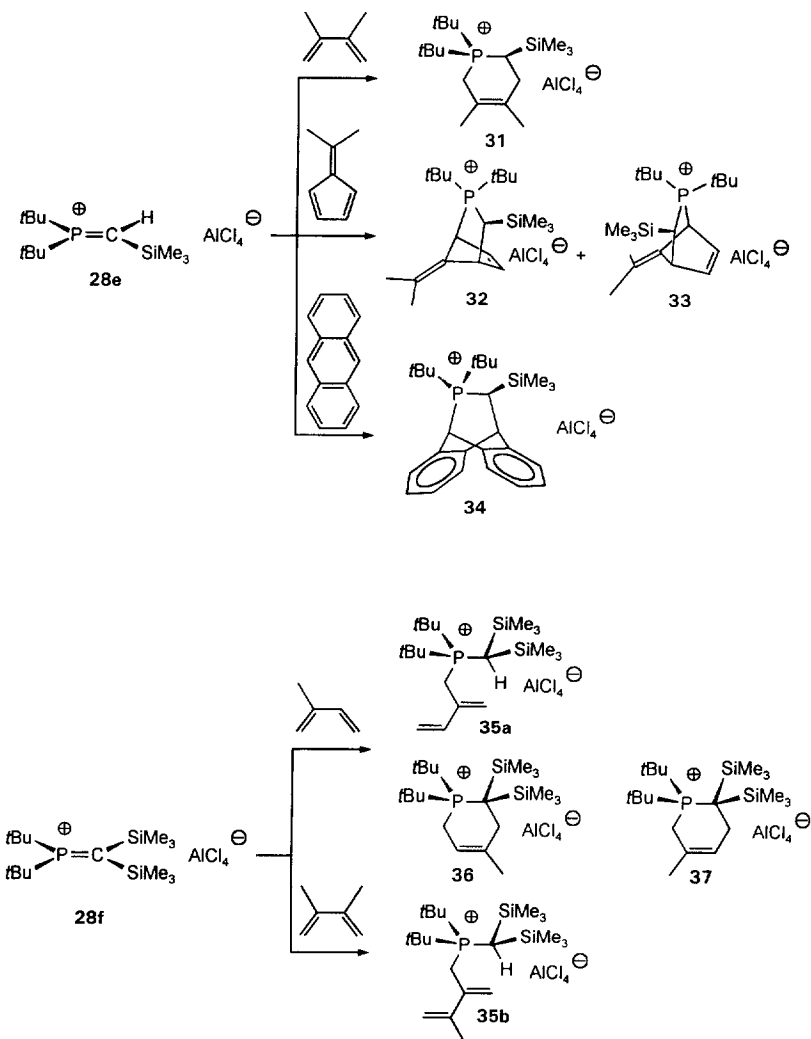

Scheme 14.

product of an ene-reaction **35a** and the [2+4]-cycloadducts are obtained in a approximately 1:1:1 ratio (Scheme 14). However, 2,3-dimethylbutadiene reacts predominantly to give the product **35b** of an ene-reaction and only about 8% of the corresponding cycloadduct is formed. Increasing steric interactions, either by substitution at the C-terminus of methylenephosponium ions and/or by introducing additional substituents in the diene, obviously increases the amount of ene-product. Also, when 2,3-dimethylbutadiene is used as a substrate the ene-product is statistically favored. Although not investigated in greater detail, it was found that the reaction of C-diarylsubstituted methylenephosponium ions with dienes proceeds

slower but gives a similar range of products. The observed reactivity of methylenephosphonium salts **28a–f** resembles closely the one observed for isoelectronic silaethenes, $R_2Si=CR_2$ [86], and is in accord with the theoretically predicted double bond character of the P=C bond in phosphanyl substituted carbenium ions.

When the C-aryl and C-silyl substituted phosphorus ylides **38a,b** are reacted with $AlCl_3$, the expected methylenephosphonium salts **40a,b** could not be isolated, but the previously unknown dihydrophosphetium salts **39a,b** are obtained almost quantitatively (Scheme 15) [87].

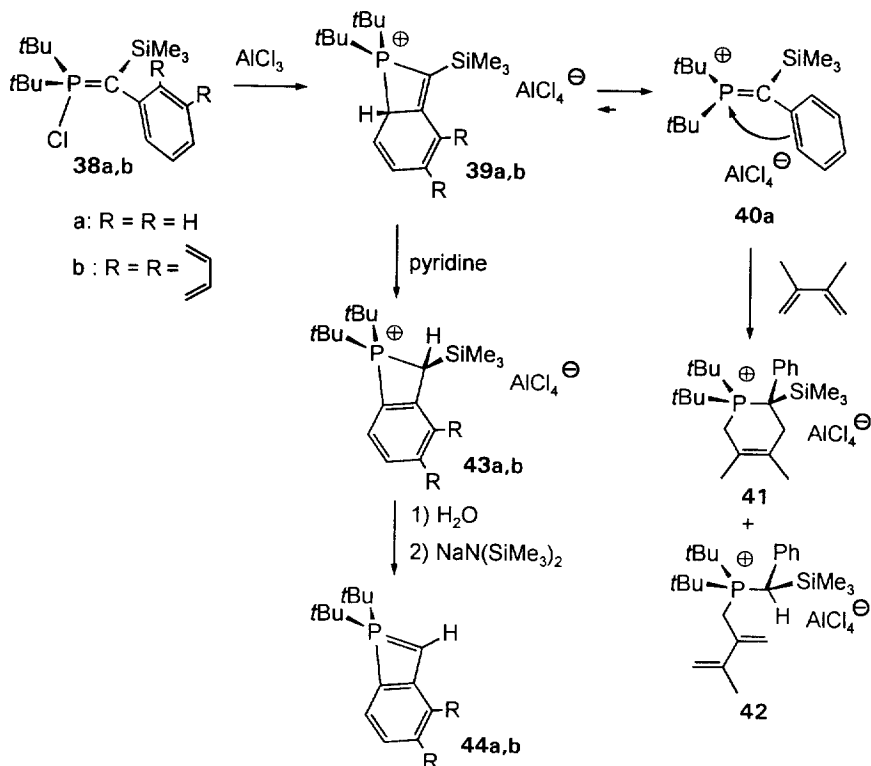

Scheme 15.

The formation of **39a,b** is explained by an intra-molecular electrocycloisatation in which the highly electrophilic phosphorus center is attacked by the arene group. This cyclisation may be compared with the Bischler–Napieralski cyclisation of iminium ions $R_2N=CR_2'^{\oplus}$, in which the C-terminus acts as a electrophilic center [88].

By trapping experiments with 2,3-dimethylbutadiene, the presence of **40a,b** in equilibrium with the heterocycles **39a,b** is suggested. The [2+4]-cycloadduct **41** and ene-reaction product **42**, both typical products when free methylenephosphonium are reacted with dienes, are obtained in a 2:1 ratio.

The heterocycles **39a,b** which can be regarded as intramolecular σ -complexes rearrange in the presence of a base (i.e. pyridine) quantitatively into the cyclic phosphonium salts **43a,b**. This base assisted rearrangement can be compared with the thermodynamically favored isomerization of *ortho*-isotoluene (3-methylene-1,4-cyclohexadiene) to toluene. After hydrolysis of the AlCl_4^- counter anion and cleavage of the Me_3Si group, the λ^5 -phosphetes **44a,b** can be prepared from **43a,b** by deprotonation with sodium bis(trimethylsilyl)amide [89].

Silylsubstitution leads to an enhanced polarity of the $\text{P}^{\delta+}=\text{C}^{\delta-}$ bond (Scheme 8) and increases the reactivity of methylenephosphonium salts like **28e,f** and **40a,b** as demonstrated above. In contrast to stable C-diaryl substituted **28a–d**, the C-bis(silylated) methylenephosphonium salt **28f** is unstable. Even in the solid state at low temperatures it rearranges slowly to yield the hydrophosphonium salt **45a** almost quantitatively, when moisture and oxygen are carefully excluded (Scheme 16) [90].

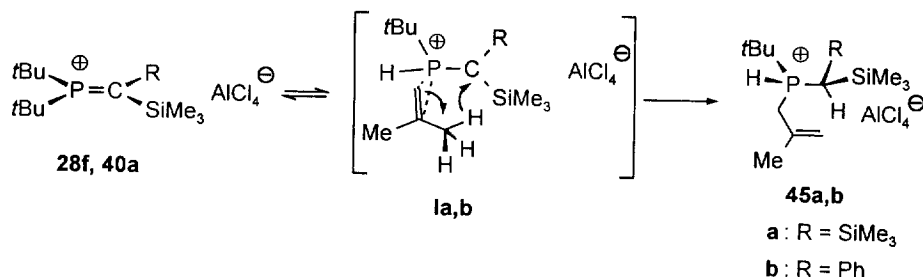

Scheme 16.

The same reaction takes place when dihydrophosphetium salt **39a** is kept in CH_2Cl_2 solution at room temperature. It is likely, that the rearrangement proceeds again *via* the spectroscopically undetectable C-phenyl-C-silyl substituted methylenephosphonium salt **40a**. The structure of the sensitive phosphonium salts **45a, b** is undoubtedly proven by multi-nuclear NMR spectroscopy. As a mechanism for this rearrangement, we suggest a β -hydrogen abstraction from the methyl group of one *tert.*-butyl substituent by the highly electrophilic phosphorus center. Intermediates **Ia, b** can be regarded as π -complexes of P-hydro-methylenephosphonium salts $t\text{BuHP}=\text{CR}(\text{SiMe}_3)^{\oplus}$ (R = SiMe₃, Ph) and isobutene which may form reversibly. An ene-reaction, as described above leads, finally and irreversibly to **45a,b**. Although this assumption has to be proven, it again makes clear that in phosphanyl substituted carbenium ions the phosphorus center is highly electrophilic. There is precedence for both, β -hydrogen abstraction by electrophilic reaction centers (i.e. $\text{AlEt}_3 \rightarrow \text{HAlEt}_2 + \text{H}_2\text{C}=\text{CH}_2$ [91,92]) and π -complexation of olefins by the electrophilic silicon center in $\text{R}_2\text{Si}=\text{CR}_2$ as a primary step in the course of non-concerted [2+4]-cycloadditions or ene-reactions of isoelectronic silaethenes [93].

The complete cleavage of one of the *tert.*-butyl groups from methylenephosphonium salts **46a–e** is observed when these are generated with SnCl_2 as weak Lewis acid and chloride acceptor from P-chloro ylides **27a–d** and **38a** (Scheme 17).

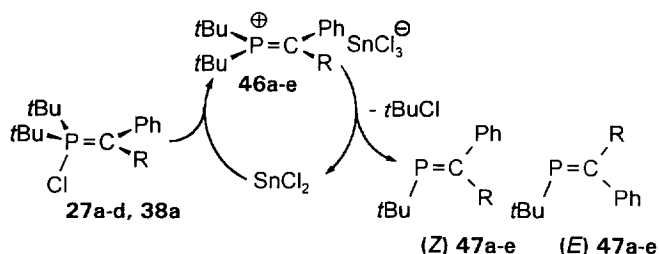

Scheme 17.

The methylenephosphonium ions of **46a–e** were detected by ^{31}P NMR spectroscopy. They decompose in a first order process ($t_{1/2}$ 3–20 min) to methylenephosphanes **Z-47a–e** and **E-47a–e**, *t*BuCl, and SnCl_2 . Therefore catalytic amounts of SnCl_2 are sufficient to generate the unsaturated organophosphorus compounds **47a–c** whereby the *E*-isomer is strongly favored with increasing steric encumbrance (i.e. **E-47d,e** >97%) [79,80]. The mechanism of this reaction is still unclear.

6. Carbenium ions stabilized by heteroatoms from group 16 (O, S, Se, Te)

6.1. Quantum mechanical calculations

In their pioneering experimental work, Taft et al. measured the appearance potential and relative stabilization energies SE of mono-substituted carbenium ions $\text{R}_n\text{XCH}_2^{\oplus}$ ($n=2$, $\text{X}=\text{N}$, P ; $n=1$, $\text{X}=\text{O}$, S ; $n=0$, $\text{X}=\text{F}$, Cl , Br , I) by mass spectrometry [60] and found that the MeSCH_2^{\oplus} ion is 5 kcal mol^{-1} more stable than the MeOCH_2^{\oplus} ion. This result was in obvious conflict with assumptions that a second period atom is a better π -donor than a third period atom and hence stabilizes the cation by more effective charge dispersal (see also discussion in Section 5.1). Bernardi, Czimadia, Schlegel and Wolfe first investigated the ions HOCH_2^{\oplus} and HSCH_2^{\oplus} and calculated electron transfer within the σ - and π -space of these molecules [94]. They found that in HSCH_2^{\oplus} the σ - and π -electron transfer occurs in the same direction from the heteroatom to the CH_2 fragment. In HOCH_2^{\oplus} σ -electron transfer occurs – as expected according to the electronegativity scale (Fig. 1) – from the carbon to the oxygen center. Backdonation of π -electrons counterbalances the σ -charge transfer. These results were confirmed and partly extended to selenium and tellurium containing ions by subsequent theoretical investigations [26,29,30,54,56,59,95–97] and although the relative amount of σ - and π -electron transfer varies with the level of calculations, it is uniformly found that: (i) π -electron transfer from sulfur to CH_2 in HSCH_2^{\oplus} is considerably larger than σ -electron transfer; (ii) π -electron transfer from X to CH_2 in HXCH_2^{\oplus} ($\text{X}=\text{O}$, S) follows the order $\text{S} > \text{O}$. In other words, S is the better π -donor; (iii) there remains considerably total positive charge on the carbon center in HOCH_2^{\oplus} ($q(\text{CH}_2) +0.89$, $q(\text{OH}) +0.11$ at RHF/6-31G* level), whereby the carbon center in HSCH_2^{\oplus} is much less positively

charged than the HS group ($q(\text{CH}_2) + 0.38$; $q(\text{HS}) + 0.62$ at the same level) (Scheme 18) [26].

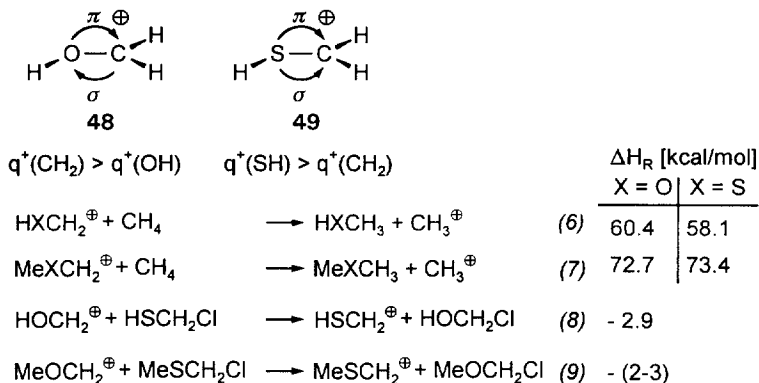

Scheme 18.

In contrast to carbenium ions stabilized by heteroatoms of group 15 (see Section 5.1.) where the analysis of electronic effects on SE 's in terms of σ - and π -charge transfer is hampered by the large variation of the energy required to planarize the pnictogen center within the group ($\text{N} \ll \text{P} < \text{As} < \text{Sb}$), the chalcogen substituted carbenium ions do not suffer from this intrinsic problem. From the discussion above it is therefore expected that substituents including the heavier heteroatoms from group 16 in the α -position will show higher SE values. Surprisingly, the theoretical and experimental values are quite diverse. The relative stabilization energies of the HXCH_2^\oplus cations were calculated several times according to isodesmic reaction (6) $\text{HXCH}_2^\oplus + \text{CH}_4 \rightarrow \text{HXCH}_3 + \text{CH}_3^\oplus$ [29,98,99]. Early *ab initio* investigations [29,30,55] rank the SE values generally according to $\text{OH} > \text{SH}$, contrary to estimates deduced from experiments in the gas phase [69,97,100]. They are, however, in accord with the observation that MeOCH_2Cl is more quickly solvolysed than MeSCH_2Cl under conditions where a $\text{S}_{\text{N}}1$ mechanism is assumed [101]. On the other hand, experimental determination of the equilibrium constant of the chloride transfer reaction $\text{MeOCH}_2^\oplus + \text{ClCH}_2\text{SMe} \rightarrow \text{MeSCH}_2^\oplus + \text{MeOCH}_2\text{Cl}$ [Eq. (9) in Scheme 18] by ion cyclotron resonance (ICR) techniques indicates that MeSCH_2^\oplus is more stable by $2.4 \text{ kcal mol}^{-1}$ [26,102]. Rodriguez and Hopkinson included the SeH group in their calculations and found the order of relative ion stability $\text{OH} > \text{SeH} > \text{SH}$ [56]. The inconclusive theoretical results as well as contradictory experiments performed in the gas and condensed phase were reviewed and discussed by Apeloig and Karni [26]. These authors have re-evaluated by *ab initio* methods (MP3/6-31G*) the ability of α -oxy and thio substituents to stabilize a carbenium ion by use of the isodesmic reactions (6)–(9) (Scheme 18). They found that HOCH_2^\oplus is $2.3 \text{ kcal mol}^{-1}$ more stable than HSCH_2^\oplus based on the calculated reaction energy of Eq. (6). Methyl substitution at the oxygen or sulfur center reverses the stability order, i.e. MeSCH_2^\oplus is $0.7 \text{ kcal mol}^{-1}$ more stabilized than MeOCH_2^\oplus [Eq. (7)]. However, the exothermicity of chloride transfer reactions (8) and (9)

indicates higher stabilities of RSCH_2^{\oplus} over ROCH_2^{\oplus} even for $\text{R}=\text{H}$. This is due to the fact that ROCH_2Cl is considerably more stabilized ($\approx 6 \text{ kcal mol}^{-1}$) by the anomeric effect than RSCH_2Cl . Apparently contrasting results may be explained, when the relative ground state stabilities of all species involved in the reactions are carefully inspected [26,29]. Finally, the basis set dependence of isodesmic reaction energies (6)–(9) makes inclusion of polarization functions (i.e. at least 6-31G* basis set) and electron correlation (MP2 or higher) necessary to obtain reliable data. In most recent calculations at very high levels (QCISD(T)/DZ++PP//MP2(full)/DZ+P or MP2/LANL1DZ+P'), the HSCH_2^{\oplus} ion was found to be more stable than HOCH_2^{\oplus} ($\approx 4 \text{ kcal mol}^{-1}$). Schleyer et al. [59] and we have calculated the stabilization energies of SeH and TeH mono-substituted carbenium ions and found in agreement that these are more stable than HOCH_2^{\oplus} . The *SE* differences of the mono-substituted cations are however small, which can be clearly seen from the graphical presentation of *SE*'s for various ions $(\text{HX})_n\text{CH}_3^{\oplus-n}$ ($\text{X}=\text{O}, \text{S}, \text{Se}, \text{Te}$) in Fig. 2. $\{SE\text{'s} [\text{kcal mol}^{-1}] \text{ in } \text{HXCH}_2^{\oplus}: 67.72 (\text{X}=\text{Te}), 65.65 (\text{X}=\text{S}), 64.40 (\text{X}=\text{Se}), 63.83 (\text{X}=\text{O})\}$.

Since donation of π -electrons and withdrawal of σ -electrons in HOCH_2^{\oplus} counteract each other and are of comparable magnitude (in contrast to iminium ion $\text{H}_2\text{NCH}_2^{\oplus}$ where π -donation is larger than σ -attraction; *vide supra*) one might ask the question why oxy substituted carbenium ions are that stable at all? Bernardi et al. [55] and Karni and Apeloig [26] pointed out that the mechanisms of stabilization must be quite different in oxy and thio substituted systems. In particular, it was found that:

(i) Stabilization evoked by σ -effects is related to bond shortening in the HXCH_2^{\oplus} cations compared to the methanes HXCH_3 and is larger for $\text{X}=\text{O}$ or N than for $\text{X}=\text{S}$ or P (about equal for $\text{X}=\text{F}, \text{Cl}$) [55].

(ii) The stability of a carbenium ion cannot be *a priori* related to π -donation or charge dispersal caused by the adjacent heteroatom.

We felt that the effect of polysubstitution on *SE* might help to gain more insight

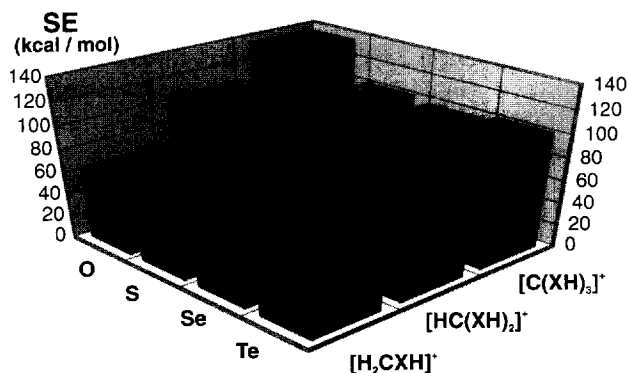

Fig. 2. Graphical representation of stabilization energies *SE* (in kcal mol^{-1}) for cations $(\text{HX})_n\text{CH}_3^{\oplus-n}$ ($\text{X}=\text{O}, \text{S}, \text{Se}, \text{Te}$) calculated from $(\text{HX})_n\text{CH}_3^{\oplus-n} + n\text{CH}_4 \rightarrow n\text{HXCH}_3 + \text{CH}_3^{\oplus}$.

into the electronic nature of C–X bonds (X=O, S, Se, Te) and have calculated the complete set of methanes (HX)_nCH_{4–n} and cations (HX)_nCH_{3[⊕]–n}. Selected data are listed in Table 1 [98, 103].

The C–X bond lengths in the monocations are close (the X=Te is even shorter) to the C=X double bond distances in H₂C=X molecules [97] and increase gradually from the mono- to the tri-substituted cations. In Table 1 we have included the relative percentages of C–X bond shortening in the cations (HX)_nCH_{3[⊕]–n} compared to the calculated C–X single bond data in the corresponding methanes (HX)_nCH_{4–n}. In all oxy substituted cations (HO)_nCH_{3[⊕]–n} (n=1–3) the C–O bond varies relatively little and is about 10% shorter than in the methanes. Contrary there is a significant increase of the C–X bond distances with increasing number of HX substituents in the thio-, seleno- and telluro-substituted series. This can be expected, if partial double bond character resulting from π-donation is a sufficient model to describe the C–X bonds in these cations which is obviously only the case for X=S, Se and Te but not for X=O.

To quantify the relative stabilization energies *SE* in (HX)_nCH_{3[⊕]–n} the hydride transfer reaction energies were calculated according to Eq. (10):



For all X, the stabilization energies increase as the number of XH groups in the ions increase as is shown graphically in Fig. 2. There is no linear increase of *SE* with the number of substituents HX. For the oxy substituted carbenium ions, introduction of the second and third HO substituent leads to about 80 and 70% of the expected *SE*'s based on the value obtained for the mono-substituted HOCH_{2[⊕]} ion. For the thio-, seleno- and telluro-substituted ions this drop-off in *SE* is even more pronounced (70 and 50%, respectively) and consequently inverses the ordering of stabilities found in the mono-substituted cations (*vide supra*). The (HO)₂CH[⊕] and (HO)₃C[⊕] ions are about 18 and 38 kcal mol^{–1} more stable than the homologous S, Se and Te containing ions. Note that the telluro-substituted ions are always slightly more stable than the corresponding thio- or seleno-analogues, the latter being always the least stable. However, the differences among them are only a few kilocalories per mole [1–4 kcal mol^{–1}]. These results are surprising in the light of the decreasing electronegativities O>>S>Se>Te and σ- and π-donating ability of the heteroatoms, which increases within this row as discussed above. A natural

Table 1

Calculated C–X bond lengths (Å) of the methanes HXCH₃, aldehydes X=CH₂ and ions (HX)_nCH_{3[⊕]–n} (n=1–3); relative shortening with respect to the single bond distance C–X in the corresponding methanes (HX)_nCH_{4–n} is given in parentheses

	HXCH ₃	X=CH ₂	HXCH _{2[⊕]}	(HX) ₂ CH [⊕]	(HX) ₃ C [⊕]
X=O	1.429	1.199 (16.1%)	1.260 (11.8%)	1.278 (9.6%)	1.289 (8.0%)
X=S	1.814	1.616 (10.9%)	1.619 (10.7%)	1.672 (7.8%)	1.710 (6.1%)
X=Se	1.969	1.752 (11.0%)	1.760 (10.6%)	1.817 (7.7%)	1.860 (5.7%)
X=Te	2.158	1.952 (9.5%)	1.940 (10.1%)	2.003 (7.3%)	2.056 (5.2%)

population analysis (NPA) was carried out for all cations $(HX)_nCH_3^{\oplus-n}$ and the result is shown graphically in Fig. 3.

In all hydroxy-substituted carbenium ions the carbon center remains positively charged and exceeds even unity in the most stable ion $(HO)_3C^{\oplus}$ ($q(C) = +1.212e$). Instead of charge dispersal an increased charge separation occurs. In contrast, in all thio-, seleno- and telluro-analogues the carbon center carries a negative charge which increases again with the number of HX substituents. In the $(HTe)_3C^{\oplus}$ ion which is the most stable of the S, Se or Te substituted ions the negative charge on carbon exceeds unity as well [$q(C) = -1.339e$]. We can thus conclude that in all $(HX)_3C^{\oplus}$ cations the Coulomb term contributes significantly to the stability. This effect is most pronounced in the oxy substituted carbenium ions which have *highly polar* and *short* $C^{\delta+}-O^{\delta-}$ bonds. This interpretation explains as well the relatively constant C–O bond distances in all $(HO)_nCH_3^{\oplus-n}$ ions (Table 1). The homologous cations $(HX)_nCH_3^{\oplus-n}$ ($X=S, Se, Te$) are stabilized by σ - and π -donation and the electron shift goes beyond formal charge dispersal. The resulting $C^{\delta-}-X^{\delta+}$ polarization contributes to the stability of the cations. The nearly equal *SE* values of the mono-substituted cations are fortuitous and result from different mechanisms of charge stabilization, which became clear only by regarding the multiple substituted systems. If we try to visualize the bonding in carbenium ions by resonance structures to express π -donation as in Scheme 1, heteroatoms X of the higher periods should be used in contrast to what is found in most textbooks.

An even more detailed insight into the electronic structure of the $(HX)_3C^{\oplus}$ cations was obtained by analyzing the Laplacians $-\nabla^2\rho(r)$ of the total one-electron density $\rho(r)$. The advantage of this method developed by Bader [104] is that no arbitrarily chosen set of localized orbitals (like σ - and π -orbitals) is used to describe bonding in a molecule. Any questionable discussion of the *spatial structure* of the electron

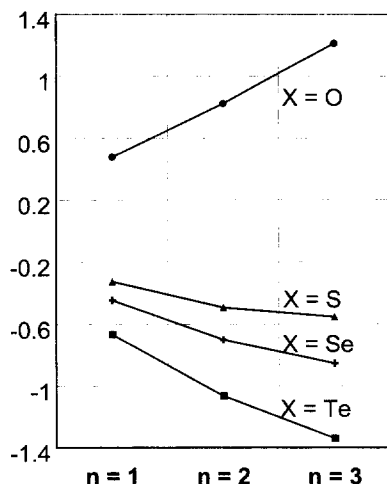

Fig. 3. Graphical representation of total charges on the carbon center of $(HX)_nCH_3^{\oplus-n}$ based on NPA calculations at MP2(full)/LANLIDZ+P' level.

distribution and therewith related stability of an electronic system by use of individual orbitals is therefore avoided. Furthermore, the total electron density ρ is an observable property of a molecule but may be more easily calculated with sufficient accuracy using quantum mechanical routines. The Bader analysis was carried out with the program MORPHY [105] and we shall discuss the C_{3h} symmetrical cations $(HX)_3C^{\oplus}$ ($X=O, S, Se, Te$) in some detail here. In Fig. 4 a relief map of the total one electron density $\rho(r)$ is shown.

There are no maxima within the total electron density that can be associated with bonding or non-bonding electrons. Instead maxima are only visible at the positions of the nuclei (see for instance the positions of the H atoms) from which ρ decays monotonically. At best, the different polarization of the C–X bonds can be seen when for instance plots of $\rho(r)$ for $(HO)_3C^{\oplus}$ (Fig. 4A) and $(HS)_3C^{\oplus}$ (Fig. 4B), are compared. However, any definition of σ - and π -bond character is not *ad hoc* possible. A detailed topological analysis of $\rho(r)$ can be achieved by calculating the Laplacians $-\nabla^2$ of $\rho(r)$ which are shown in Figs. 5 and 6.

Local concentrations and depletions of charge become now visible which were hidden in the total electron density and allow the assignment of bonding electron and “lone” pair electron domains. The shell structure of the inner electron core of the “atoms in molecules” becomes evident as well. Only the outermost valence electron shell of each single atom is deformed leading to local humps (concentrations) where bonds to the neighboring atoms are formed. On the other hand, valleys or

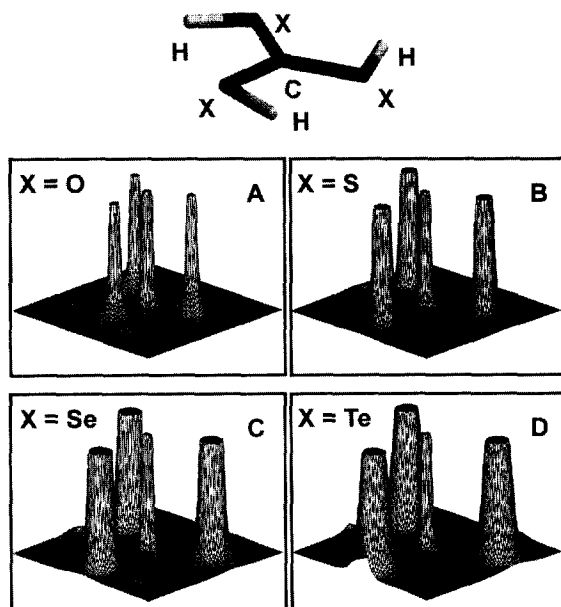

Fig. 4. Relief map of the total electron density $\rho(r)$ (in a.u.) for a plane containing all nuclei of the cations $(HX)_3C^{\oplus}$ ($X=O, S, Se, Te$). The orientation of the cations is shown on top. Values above 5.0 a.u. are not shown. (A) $(HO)_3C^{\oplus}$; (B) $(HS)_3C^{\oplus}$; (C) $(HSe)_3C^{\oplus}$; (D) $(HTe)_3C^{\oplus}$.

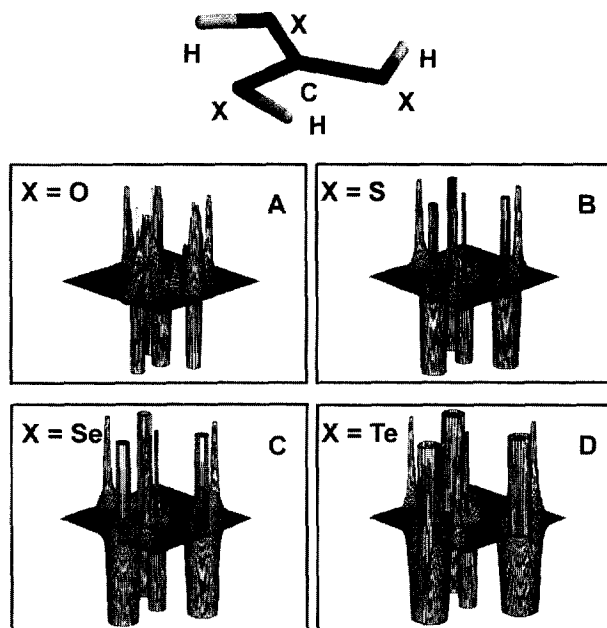

Fig. 5. Three-dimensional plot of Laplacians $-\nabla^2\rho(r)$ (in a.u.) for $(HX)_3C^\oplus$ for the plane including all nuclei. The orientation of the cations is shown on top. (A) $(HO)_3C^\oplus$; (B) $(HS)_3C^\oplus$; (C) $(HSe)_3C^\oplus$; (D) $(HTe)_3C^\oplus$.

even deep holes indicate regions of charge depletion. In a nonbonding atom the valence charge density is uniformly and spherically distributed. In Fig. 5A, at the positions where the C–O bonds of $(HO)_3C^\oplus$ are assumed large humps form in the valence shell of the carbon center which are polarized towards the oxygen atoms leading to charge depletion at the carbon center. The lone pairs at the O centers which are not involved in C–O bonding show up as large peaks close to the O nuclei. In Fig. 5B, again humps in the valence shell of the inner carbon center indicate C–S bonds but these are now polarized towards the C-atom. Note furthermore the smaller and spatially more extended lone pairs at the sulfur centers which are visible as hills in the relief map. For the cations $(HSe)_3C^\oplus$ (Fig. 5C) and $(HTe)_3C^\oplus$ (Fig. 5D) there are no lone pairs detectable at the Se or Te centers as local charge concentrations but deep valleys indicate charge transfer towards the carbon centers and depletion at the Se and Te centers. In Fig. 6, two-dimensional plots of the Laplacians are shown where charge concentration is indicated by solid lines and charge depletion by dashed lines. Furthermore, contour lines of the zero-flux surfaces which separate atoms in molecules [104] and C–X bond paths are included. The bond critical points which correspond to the intersections of the zero-flux surfaces with the bond paths are indicated by squares (■). The *umpolung* of the C–X bonds is demonstrated as well as the very different sizes of the carbon atoms in $(HO)_3C^\oplus$ on one side and in $(HX)_3C^\oplus$ (X=S, Se, Te) on the other. The

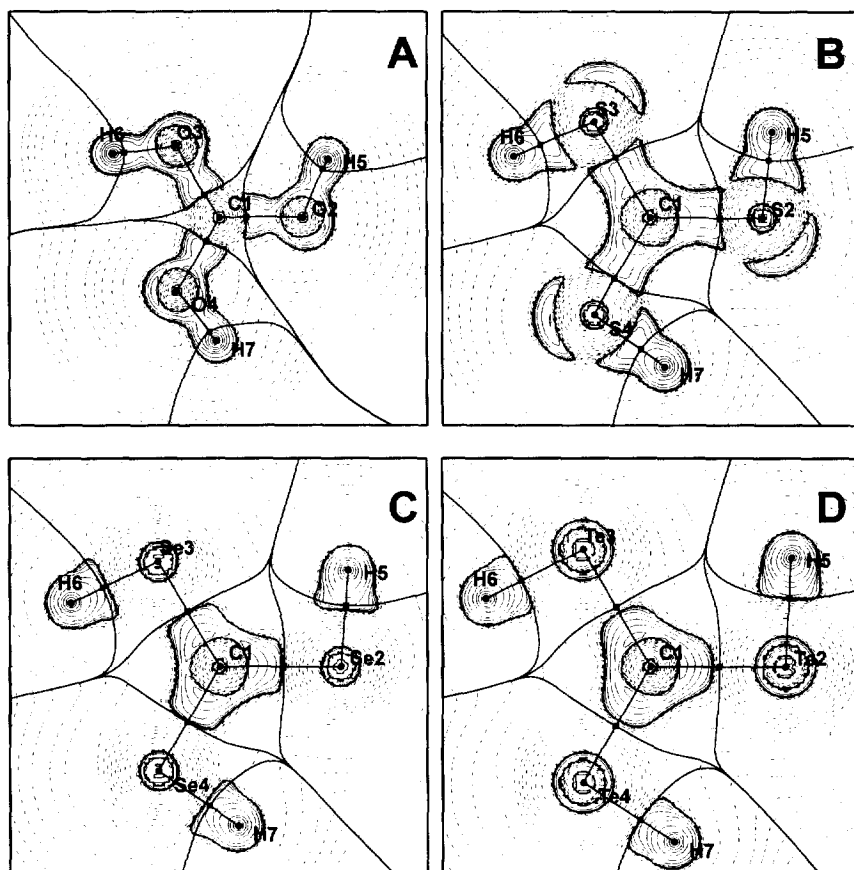

Fig. 6. Two-dimensional plot of Laplacians $-\nabla^2\rho(r)$ (in a.u.) for $(HX)_3C^\oplus$ for the plane including all nuclei. Solid lines indicate charge concentration, dashed lines charge depletion. Interatomic zero-flux surfaces and bond paths are shown as solid bold lines. Bond critical points are indicated by squares (■). (A) $(HO)_3C^\oplus$; (B) $(HS)_3C^\oplus$; (C) $(HSe)_3C^\oplus$; (D) $(HTe)_3C^\oplus$.

results of a topological analysis of the wave functions used to describe the cations $(HX)_3C^\oplus$ are given in Table 2.

The small value for r_b which is given by the ratio of the distance between the carbon center C to bond critical point (■) and distance C–X indicates a steep decrease of electron density at the carbon center of $(HO)_3C^\oplus$ and charge separation over the strongly polar C–O bond path. Furthermore, a small ellipticity value ϵ_b defining the π -character of the C–X bonds, indicates little π -donation from oxygen towards carbon. The ellipsoidal shape of the C–X bond given by ϵ_b is largest for the carbon sulfur bond and decreases in the order C–S > C–Se > C–Te \gg C–O. The ρ_b value is indicative of charge concentration within the C–X bond and is highest for the C–O bond due to the high attractive forces evoked by both the carbon and oxygen nucleus.

Table 2

Results of the topological analysis for the wave function of $(\text{HX})_3\text{C}^\oplus$ (X=O, S, Se, Te)

C–X	r_b	ρ_b [e · Å ⁻³]	$\nabla^2\rho$ [e · Å ⁻⁵]	$H(r_b)$ [Hartree · Å ⁻³]	ε_b
C–O	0.322	2.553	–5.021	–4.337	0.047
C–S	0.624	1.446	–2.655	–1.770	0.742
C–Se	0.530	1.135	1.835	–0.763	0.311
C–Te	0.513	0.804	4.128	–0.399	0.240

r_b = location of the bond critical point given by the ratio of distances C–■/C–X; ρ_b = electron density at the bond critical point; $\nabla^2\rho_b$ = value of the Laplacian at the bond critical point; $H(r_b)$ = energy density at the bond critical point, ε_b = ellipticity at the bond critical point [106].

The Laplacian $\nabla^2\rho_b$ and the energy density $H(r_b)$ at the bond critical point are further valuable sources for the characterization of a bond [104]. The sign of the Laplacian is determined by the sum of the three curvatures at the bond critical point. One of these, namely the curvature along the bond path is positive and the other two perpendicular to the bond path are negative. The energy density $H(r_b)$ is given by $H(r_b) = G(r_b) + V(r_b)$ where $G(r_b)$ is the kinetic energy which is always positive and $V(r_b)$ is the potential energy of the electrons at the bond critical point which is always negative. Both, $\nabla^2\rho_b$ and $H(r_b)$ are negative for $(\text{HO})_3\text{C}^\oplus$ and $(\text{HS})_3\text{C}^\oplus$ which is characteristic for covalent or polar bonds in which charge is shared by both nuclei.

The discussion of the topology of the Laplacians for $(\text{HSe})_3\text{C}^\oplus$ and $(\text{HTe})_3\text{C}^\oplus$ is more problematic since $\nabla^2\rho_b$ is now positive which is characteristic of ionic bonds or van der Waals interactions (closed shell interactions) where charge is not shared by both nuclei. However, the energy density $H(r_b)$ is still negative so that the C–Se and C–Te bonds still can be considered as binding shared interactions. The positive Laplacians and non-observable lone pairs at the Se and Te centers in the contour maps of $\nabla^2\rho_b$ (Figs. 5C and D and Figs. 6C and D) are the effects of the large atomic basins of selenium and tellurium in which the *valence electrons* are poorly localized. Using all these criteria to characterize the C–X bonds in connection with the ordering of the relative stabilization energies SE , it is clearly evident that highly polar (expressed by formal charges on C and X) but still covalent bonds (expressed by $\nabla^2\rho_b$, $H(r_b)$ and ρ_b) are most effective to stabilize a α -heteroatom substituted carbenium ion relative to CH_3^\oplus . These factors are most pronounced in $(\text{HO})_3\text{C}^\oplus$. Indeed, as was already stated by Apeloig et al., the correlation between the degree of assumed charge dispersal and carbenium ion stability is very limited [26]. As will be outlined below, the interpretations given above are in accord with conclusions from recent experimental work.

6.2. Experimental results

6.2.1. Synthesis and physical properties of chalcogeno substituted carbenium ions

Oxygen- and sulfur-substituted carbenium ions have been extensively studied [7,9,12,15,16,20,24] since Klages, Zange [107] and Meerwein [108] synthesized the

first tri(alkoxy)-substituted derivatives either by alkylation of a carbonic ester [Eq. (d)] or by abstraction of an alkoxy group from an ortho ester by BF_3 [Eq. (a)] (Scheme 19).

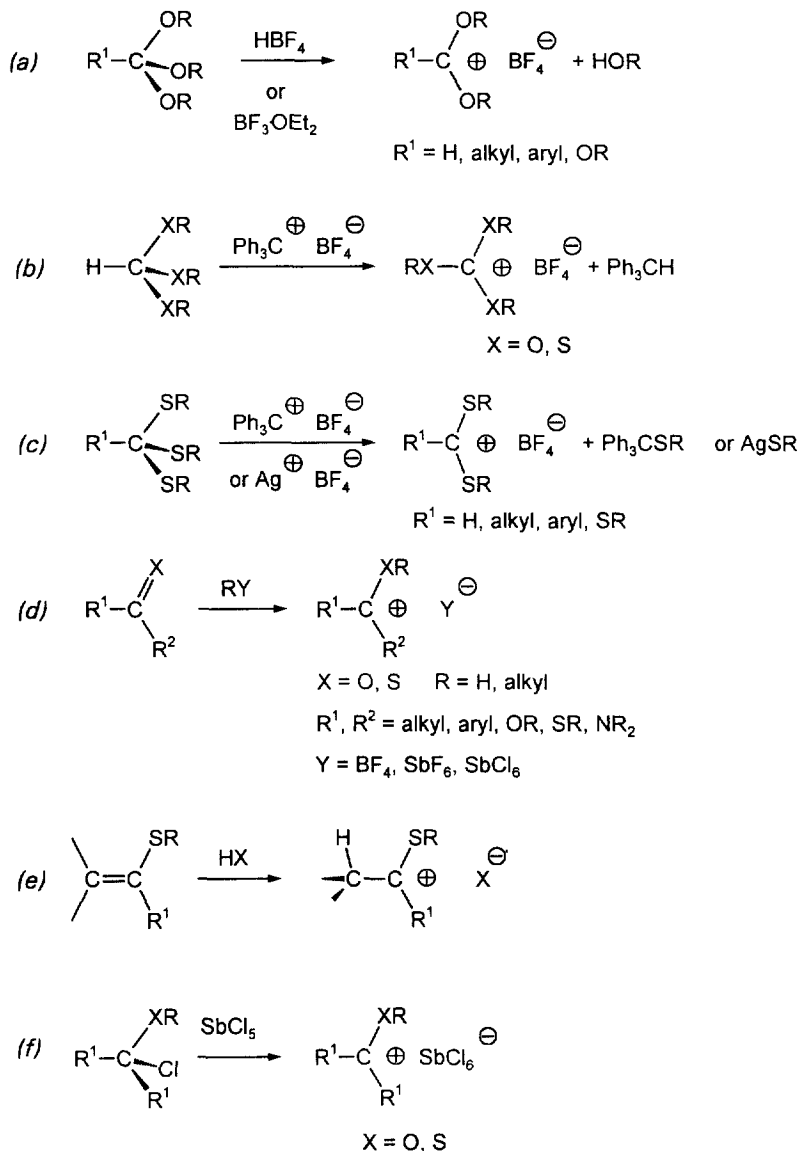

Scheme 19. General scheme for the preparation of oxy- and thiocarbenium salts.

Protonation or alkylation of a carbonyl or thiocarbonyl compound [Eq. (d)] or abstraction of a leaving group by a Lewis acid [Eqs. (a)–(c)] are most commonly

used to prepare oxy- [109] and thio-substituted carbenium ions [20,24]. These methods have been applied for the preparation of mixed substituted carbenium ions CXYZ as well (X, Y, Z=any combination of OR, SR, NR₂).

The parent tri(hydroxy)carbenium ion, (HO)₃C⁺, is obtained when carbonate, hydrocarbonate or (tBuO)₂C=O is treated with fluorosulfonic acid and SbF₅ in liquid SO₂. The ion is stable up to -50 °C and then decomposes to CO₂ and H₃O⁺ [110]. Vinyl sulfides and ketene thioacetals are protonated in the β-position [Eq. (e)] to give the corresponding mono- and di-substituted thio-carbenium ions [24,111]. Carbenium ions with one alkoxy or thioxy substituent may be prepared by halide abstraction from α-halogen ethers and a Lewis-acid like SbCl₅, SnCl₄ or TiCl₄ [Eq. (f)] [22,112,113]. This reaction is very versatile to generate carbenium ions as reactive intermediates but less commonly used when the α-thiocarbenium ions are to be isolated and obviously fails for some sulfur containing ions [24]. When cyclic dithioacetals are reacted with SO₂Cl₂, however, cyclic dithio-carbenium salts were isolated as crystalline solids containing the HCl₂⁻ anion [114]. It is very likely that α-chloro dithioacetals are intermediates in this reaction which lose chloride in the presence of HCl.

In contrast to oxy- and thiocarbenium ions, selenium-stabilized carbenium ions are much less investigated [115]. There are a number of cationic cyclic compounds known in which the selenium centers are either incorporated in a conjugated 6π-system or the positive charge is delocalized by other stabilizing substituents like cyclopropylm units or amino groups. Hevesi et al. isolated the first bis(selenium) stabilized acyclic carbenium ions **51** when orthoselenoesters **50** were reacted with either Ph₃C⁺BF₄⁻ or a silver salt containing an anion of low nucleophilicity (i.e. BF₄⁻, SbF₆⁻, SbCl₆⁻; Scheme 20) [99].

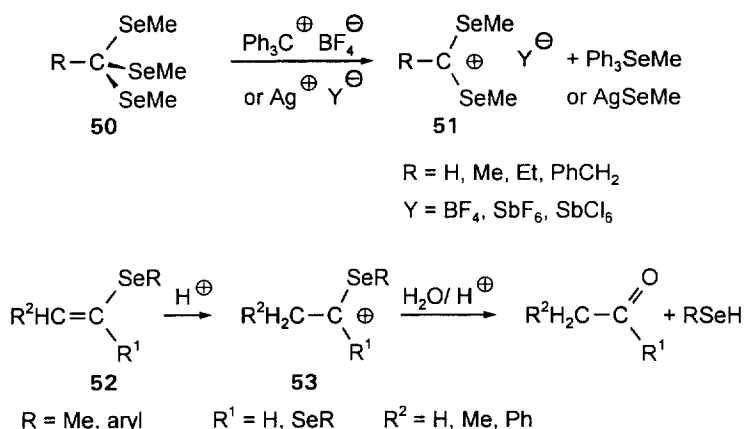

Scheme 20.

Alternatively, vinyl selenides or ketene selenoacetals (**52**: R¹ = SeR) can be protonated in the β-position at the C=C bond [116,117]. Under hydrolytic conditions carbonyl compounds and a selenol RSeH are finally obtained. Tellurium substituted

carbenium ions **57a,b** became known only very recently [103,118]. They were prepared in a formally simple substitution reaction by reacting bipyridine copper tellurolates **54** (X = Te) with tetrabromomethane (Scheme 21). Other methods described in Eqs. (a)–(d) of Scheme 19 are less practical for the synthesis of tellurocarbenium ions, because polytelluromethanes or tellurocarbonyl compounds are scarcely known as starting materials [119–121].

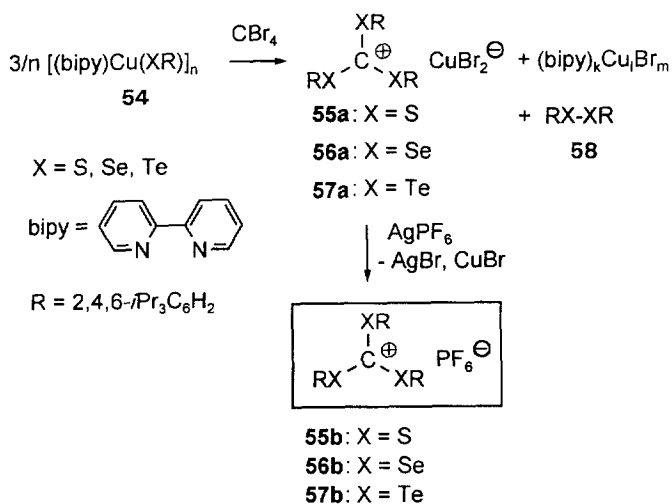

Scheme 21.

The dibromocuprate anion was subsequently replaced by PF_6^- using $AgPF_6$. The corresponding thio- and seleno-carbenium ions **55a,b** and **56a,b** were prepared in an analogous way. Only small amounts of dichalcogenates are formed in these reactions. On the contrary, they are the main products when alkali- or alkaline earth chalcogenates are reacted with haloforms [122].

There is surprisingly little structural information on carbenium ions stabilized by an heteroatom from group 16. The structure of protonated acetic acid **58** was elucidated by X-ray crystal analysis in the HSO_4^- and FSO_4^- salts [9]. The structures of 1,3-dioxolan-2-ylum salts **59** and **60** were also determined (Scheme 22) [123, 124].

The structures of some sulfur-substituted – **61** [99], **62** [125], **55b** [103] – and seleno-substituted carbenium ions – **51** [99] and **56a** [103] – as well as the structure of the tri(telluro)carbenium ion **57a,b** [103] were examined (Scheme 22). The carbon center is in all cases trigonal planar surrounded by its substituents. The experimentally determined bond angles and lengths agree satisfactorily with the calculated data (see Table 1). In the tri-substituted thiocarbenium ions **55a** and **62** the C–S bond is slightly elongated when compared to the C–S distance in **61** as expected. The experimentally determined C–Se lengths in **51** are somewhat longer and the C–Se distances in **56a** are shorter than calculated.

In Table 3 some physical data of representative chalcogeno-substituted carbenium ions are listed. They demonstrate experimentally that the bonding situations in the

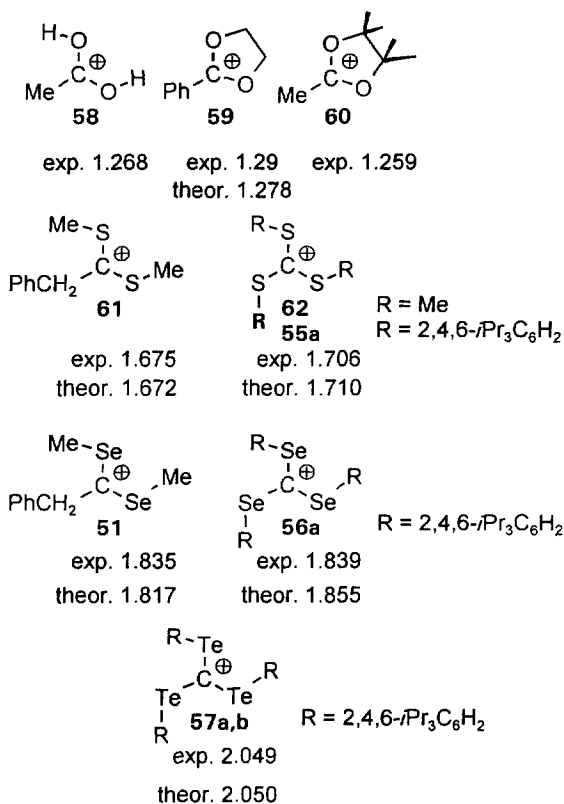

Scheme 22. Average experimental and calculated bond lengths are given in Å.

Table 3

Selected physical data of some chalcogeno-substituted carbenium ions $(HX)_2CH^{\oplus}$ and $(HX)_3C^{\oplus}$ ($X = O, S, Se, Te$); λ_{max} in nm and ϵ in $l\ mol^{-1}\ cm^{-1}$; E_p^{red} in V; MO energies and HOMO–LUMO-gaps ($\Delta E = E_{LUMO} - E_{HOMO}$) in eV

	X	^{13}C -NMR	X-NMR	λ_{max}/ϵ	E_p^{red}	E_{HOMO}	E_{LUMO}	ΔE
$(HO)_3C^{\oplus}$	O	166.3 ^c	–	<190 ^d	–	$\times 21.99$	–2.10	19.89
61	S	245	–	–	–	–	–	–
55a	S	239.5	–	309/31065	–0.68	–	–	–
$(HS)_3C^{\oplus}$	S	–	–	–	–	–16.13	–4.72	11.41
51	Se	263	^{77}Se : –	–	–	–	–	–
56a	Se	253.7	788/836	388/16835	–0.65	–	–	–
$(HSe)_3C^{\oplus}$	Se	–	^{77}Se :770	–	–	–14.77	–4.69	10.08
57b	Te	230.6	–	500/22940	–0.67	–	–	–
$(HTe)_3C^{\oplus}$	Te	–	^{125}Te : 1279	–	–	–13.15	–4.70	8.45

The redox potentials E_p were determined in a CH_3CN/nBu_4NPF_6 electrolyte using a Pt-electrode vs a Ag-electrode (ferrocene as standard). Reversible redox waves ($\Delta E = 85\ mV$) for **55b** at $T = 298\ K$, for **56b** and **57b** at $T = 238\ K$.

thio-, seleno- and telluro-substituted ions are very similar, while they are clearly distinct from those in $(\text{RO})_n\text{CH}_3^{\oplus-n}$ ions.

There is a considerable downfield (high frequency) shift of the ^{13}C chemical shift of the central carbon, when oxy-substituted carbenium ions like $(\text{HO})_3\text{C}^{\oplus}$ are compared with their higher homologs. These latter ions show ^{13}C resonances in about the same range (230–270 ppm). The lowest energy absorptions in the UV/visible spectra of **55b** (pale yellow), **56b** (orange) and **57b** (violet) exhibit a bathochromic shift of 79 nm when S is replaced by Se and a further shift of 112 nm when Se is replaced by Te. On the other hand, almost identical peak potentials at -0.67 V were found for the reduction waves in the cyclovoltammograms of **55b–57b**. Note that oxycarbenium salts are colorless (no absorptions >190 nm) and are not reduced up to -2.4 V. Evidently, an increasing destabilization of the HOMO is associated with varying the α -heteroatom from O to Te. The LUMO energy, however, is less affected and remains nearly constant in thio-, seleno- and tellurocarbenium ions. This interpretation is supported by *ab initio* calculations (MP2(full)//LANLIDZ+P' level) which show that the HOMO–LUMO gap in $(\text{HO})_3\text{C}^{\oplus}$ is much larger than in $(\text{HS})_3\text{C}^{\oplus}$, $(\text{HSe})_3\text{C}^{\oplus}$ and $(\text{HTe})_3\text{C}^{\oplus}$ [103]. This explains as well the observed trend of the ^{13}C chemical shift which in these ions is mainly influenced by the paramagnetic shielding constant σ_p and hence the HOMO–LUMO gap, but not by formal charges residing on the carbon atom [123]. Hevesi et al. measured the energy barrier for rotation around the C–S and C–Se bonds in **61** (14 kcal mol $^{-1}$) and **64** (13 kcal mol $^{-1}$). They lie in the same range observed for some di(methoxy)carbenium ions (8–15 kcal mol $^{-1}$). However, although rotation barriers are often used, they are questionable as a measure of π -bond strengths in heteroatom substituted carbenium ions [26,59]. One reason is that only the 90° rotated form of $\text{HS}-\text{CH}_2^{\oplus}$ could be localized by high level *ab initio* calculations [59]. The rotated form of $\text{HO}-\text{CH}_2^{\oplus}$ converts to a C_{2v} symmetric ion with a linear C–O–H unit, when its geometry is optimized. This linear arrangement of the oxygen center which corresponds to a sp -valence configuration at oxygen allows effective π -charge transfer in the transition state as well, and is due to the low inversion barrier for planarization of a second period element (for an earlier discussion of this effect in $\text{HO}-\text{CH}^{\oplus}$ see [26]). This was already found to be the main reason for the high stabilizing ability of NH_2 groups in carbenium ions which exceeds PH_2 , AsH_2 and SbH_2 substituents although the latter are at least as effective as π -donors. The rotated conformers $\text{HSe}-\text{CH}_2^{\oplus}$ and $\text{HTe}-\text{CH}_2^{\oplus}$ rearrange into hydrogen bridged species which can be considered as side-on protonated seleno- or telluro aldehydes $\text{X}=\text{CH}_2$ ($\text{X}=\text{Se}, \text{Te}$) [59]. As pointed out in Section 5.1 this phenomenon was also observed when the rotated form of $\text{H}_2\text{P}=\text{CH}_2^{\oplus}$ was geometry optimized [60].

Hevesi et al. measured the gas phase basicities of a series of vinyl ethers **63a,b**, vinyl sulfides **64a,b** and vinyl selenides **65a,b** as well as of the ketene acetals **66**, **67** and **68** (Scheme 23) to compare experimentally the stabilizing ability of OMe- vs SMe- vs SeMe-groups [126].

From the experimentally determined proton affinities (PA) of these compounds it was concluded:

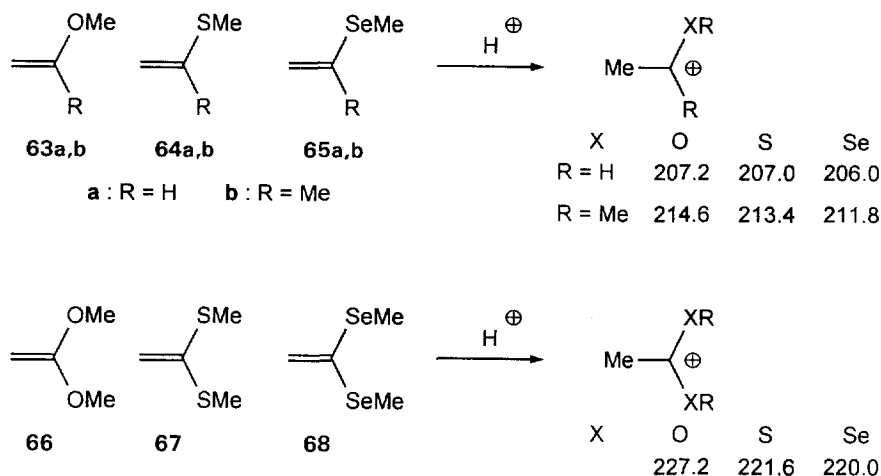
Scheme 23. Listed proton affinities (*PA*) in kcal mol⁻¹.

(i) Mono-substituted oxy-, thio- and seleno-substituted carbenium ions are stabilized in the gas phase to almost the same extent. (ii) Disubstitution by XR groups (X=O, S, Se) leads to a significantly higher stabilization for X=O (**66**-H[⊕] by 5.6 kcal mol⁻¹) while the sulfur and selenium substituted ions **67**-H[⊕] and **68**-H[⊕] have very similar *PA*'s. These results are in agreement with the conclusions from quantum mechanical calculations (see Section 6.1. The predicted reversed charge pattern for **66**-H[⊕] (C^{δ+}-O^{δ-}) and **67**-H[⊕] (C^{δ-}-S^{δ+}) was also experimentally proven by an X-ray photoelectron spectroscopy (XPS) study undertaken by Hevesi et al. [127].

6.2.2. Reactivity of chalcogeno-substituted carbenium ions

Oxy- and sulfur-substituted carbenium ions are useful synthons and their reactivity has been reviewed and will not be considered here in detail [9,15,16,21,24]. In Scheme 24, only the principles of the reactivity of thio-, seleno- and tellurocarbenium ions are shown.

Di-substituted thiocarbenium ions **69** are attacked by many reagents to give products **71** under formal transfer of a nucleophile Nuc⁻ to the central carbon. Suitable nucleophiles are hydroxide, alkoxides, thiolates and amines as well as metal hydrides and organometallic reagents. However, if the R¹ group carries an α-hydrogen center, deprotonation occurs and ketene thioacetals **70** are formed. Dithioacetals derived from formic acid (**69**: R¹=H) serve as starting materials for the generation of sulfur-stabilized carbenes **72**. Amines like Et₃N are sufficient to deprotonate **69** which demonstrates on one side the acidity of dithiomethenium salts and on the other side the stability of the carbene **72** which reacts subsequently to form either tetrathio-substituted ethenes upon dimerization or underlies fragmentation reactions. Also carbene **72** can be generated as an intermediate from the tri-substituted carbenium ion **62** when attacked by soft nucleophiles at the sulfur center.

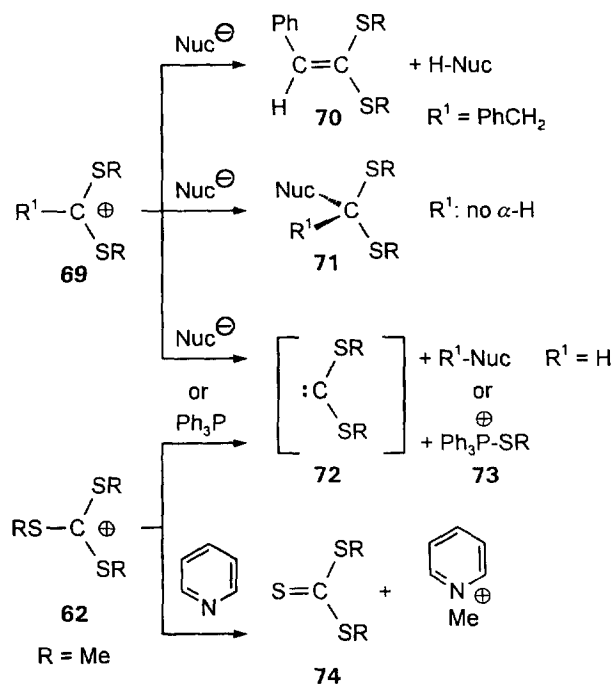

Scheme 24.

Harder nucleophiles like pyridine are alkylated by **62** and thioesters **74** are formed beside pyridinium salts. This reactivity is typically found for oxy-substituted carbenium salts. The reactivity of selenium- or tellurium-substituted carbenium ions is less well studied and some synthetically useful transformations are shown in Scheme 25.

Hevesi et al. generated selenocarbenium ions in situ from selenoacetals **50** and tin tetrachloride and studied the reaction with enols **75**. Under C–C bond formation products **76** are formed which serve as valuable precursors for further manipulations [128]. Recently, a new method for the generation of selenocarbenium ions **78** from Se, O-heteroacetals **77** and TiCl_4 was reported [129]. This method proved to be useful for the synthesis of selenaheterocycles by an intramolecular cyclisation reaction. Again the carbon center of the $\text{RSe}-\text{CH}_2^+$ unit is attacked by the nucleophilic C=C double bond which is surprising in light of the reverse polarity of the Se–C bond (*vide supra*). Therefore, it may be possible that the Lewis-acid which is added in excess (two equivalents) will complex the α -selenium center as well (compare **C** in Scheme 25). This “superelectrophilic” activation of the carbenium ions involved in this reaction as true highly reactive species may then explain the course of the reaction as well as the dependency on the Lewis-acid employed (i.e. AlCl_3 , FeCl_3 and SnCl_4 gave no cyclisation products). Viehe et al. recently reported convincing evidence for comparable highly activated sulfur-substituted carbenium ions **C** as

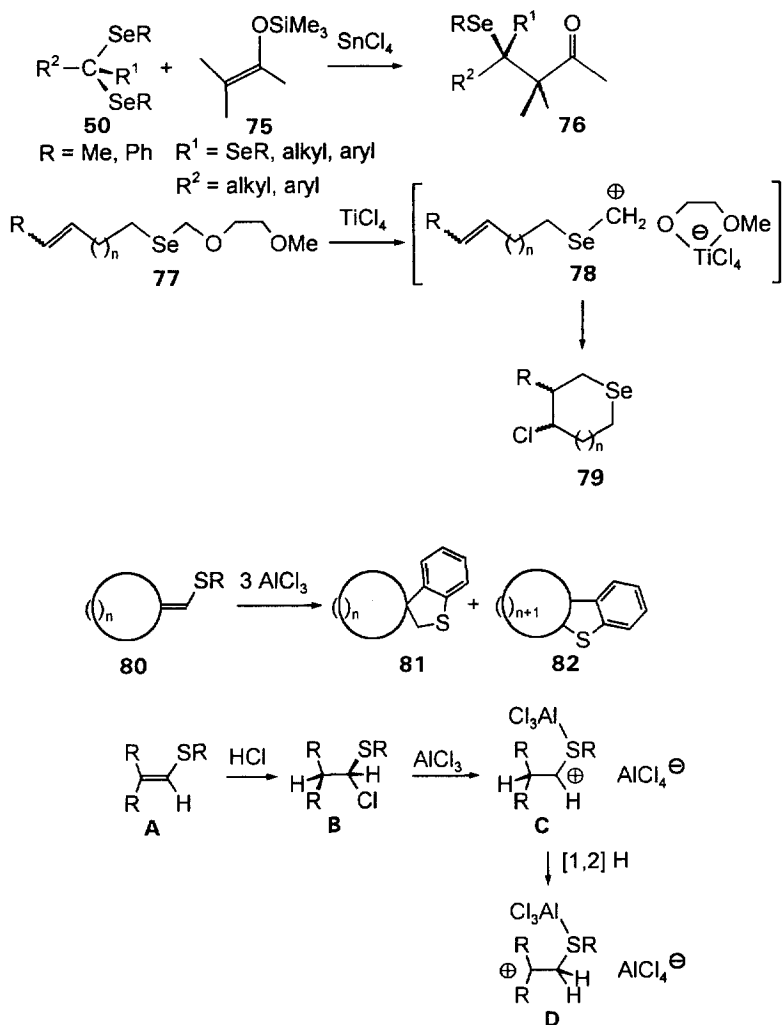

Scheme 25.

intermediates in spirocyclisations and ring expansions of (phenylthiomethylene)-cycloalkanes **80** which give **81** and **82**, respectively (Scheme 25) [130]. Hydrogenchloride which was present in AlCl₃ adds to the vinylsulfides **A** to form α-chloro sulfides **B**. These react with excess AlCl₃ to give the highly activated thiocarbenium ions **C** which then rearrange to give β-thiocarbenium ions **D** as intermediates for the cyclisation reactions. Note the unusual rearrangement of **C** to **D** which under less drastic conditions proceeds in the reverse manner due to the higher stability of thiocarbenium ions over alkylsubstituted derivatives.

The reactivity of tellurocarbenium ions remains to be explored. There is, however,

evidence that the tellurium centers will be predominantly attacked by nucleophiles. Hence, when tetraalkylammonium bromides are added to **57b** the complex salt **83** was isolated by crystallization which contains the previously unknown RTeBr_2^- as counteranion for $(\text{RTe})_3\text{C}^{\oplus}$ (Scheme 26) [71].

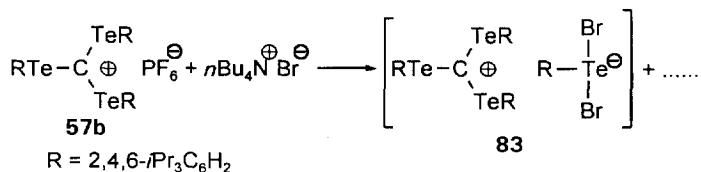

Scheme 26.

7. Carbenium ions stabilized by heteroatoms from group 17 (F, Cl, Br, I)

7.1. Quantum mechanical calculations

As for chalcogeno-substituted carbenium ions, α -halogeno carbenium ions were extensively studied by various groups. Most recent high level quantum mechanical calculations on the mono-substituted ions XCH_2^{\oplus} **84a–d** (X=F, Cl, Br, I) were performed by Schleyer et al. to elucidate the influence of π -charge transfer from the halogen center to the carbon center. Based on Eq. (1), $\text{XCH}_2^{\oplus} + \text{CH}_4 \rightarrow \text{XCH}_3 + \text{CH}_3^{\oplus}$; X=F, Cl, Br, I, the relative isodesmic stabilization energies were calculated [59] and they follow the order ICH_2^{\oplus} (38.1 kcal mol⁻¹) > BrCH_2^{\oplus} (31.8 kcal mol⁻¹) > ClCH_2^{\oplus} (31.3 kcal mol⁻¹) >> FCH_2^{\oplus} (18.0 kcal mol⁻¹). Because the stability of the cations was exclusively attributed to the π -donor capability of the α -heteroatom, the same order – I > Br > Cl > F – follows. Previously, quantum mechanical calculations were performed for halosubstituted ethyl cations and concentrated on the relative stabilities of different isomers **85**, **86** and **87** (Scheme 27) [131–134].

Generally it was found that the β -halogeno-substituted isomers **87a–c** are the least stable isomers which correspond only to transition states for X=Cl or Br [132–134]. For X=F or Cl the α -halogeno-substituted isomers **85a,b** are more stable by 25 and 3.7 kcal mol⁻¹, respectively, than the cyclic halonium ions **86a,b**. Upon inclusion of electron correlation at the MP2 level the cyclic bromonium ion **86c** becomes more stable than the classical isomer **85c** by about 3 kcal mol⁻¹ [133,134]. Both bromo-substituted ions **86c** and **85c** are more stable than any isomer of the fluoro- or chloro-substituted ions by at least 5 kcal mol⁻¹. Based on the hydride affinities HA of the α -halogeno substituted carbenium ions **85a–c**, it was shown that the stabilizing effect of the α -heteroatom follows the order Br > Cl > F in accord with the above listed ordering for methyl cations XCH_2^{\oplus} **84a–c**. Reynolds extended these investigations to the butyl cations **88a–c**, **89a–c**, and **90a–c**. The introduction of additional methyl groups does not change the ordering of the stability of the

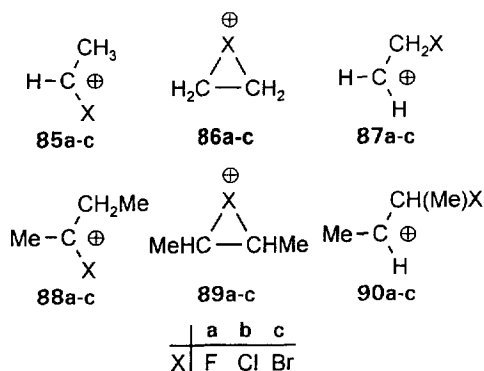

Scheme 27.

different isomers for a given halogen center, i.e. the cyclic bromonium ion **89c** is more stable than the classical ion **88c** and both are the most stable of all $C_4H_8X^\oplus$ ions. Acyclic fluoro and chloro ions **88a,b** are more stable than the cyclic isomers **89a,b**, but the energy gap between cyclic and acyclic isomers becomes smaller. However, the relative stabilities of the α -halogeno substituted $C_4H_8X^\oplus$ ions **88a–c** change and now follow the order bromine (**88c**) > fluorine (**88a**) > chlorine (**88b**). Taking the calculated HA 's of the trihalomethyl cations X_3C^\oplus **91a–c** into account which follow the order $Br > Cl \gg F$, Reynolds stated that the question of which halogen atom is a better π -donor depends much on the substitution pattern of the carbenic carbon center and that there is no simple consistent ordering. Nevertheless it was concluded that dialkyl-substituted carbenium ions like **90a–c** are less stable than cations **88a–c** substituted with a single alkyl group and one α -halogen center. Furthermore, dialkylsubstituted bromocarbenium ion **88c** is as stable as the *tert*-butyl cation Me_3C^\oplus . On the other hand trihalo-substituted carbenium ions X_3C^\oplus **91a–c** are generally less stable than dialkyl- or trialkyl-substituted carbenium ions. Surprisingly it was found that the hydride affinities calculated according to $X_nCH_{3-n}^\oplus + H^- \rightarrow H_{4-n}CX_n$ are almost the same for FCH_2^\oplus (**84a**) and F_3C^\oplus (**91a**) while they are very different for $ClCH_2^\oplus$ (**84b**) and Cl_3C^\oplus (**91b**). The latter is more stable by 30 kcal mol^{-1} than **84a,b** and **91a**. One may therefore suspect that the very different stabilities of the neutral methanes X_3CH and XCH_3 have a considerable effect on the estimates of the cation stabilities. Therefore, the reaction energies of the two isodesmic reactions Eq. (10A) and Eq. (10B) using *experimental* heats of formation, ΔH_f , of all reaction partners [135] were calculated and the result is shown graphically in Fig. 7A and Fig. 7B. Only for the triiodocarbenium ion **91d** are sufficient experimental data unavailable to calculate the stabilization energies according to Eq. (10A) and Eq. (10B).



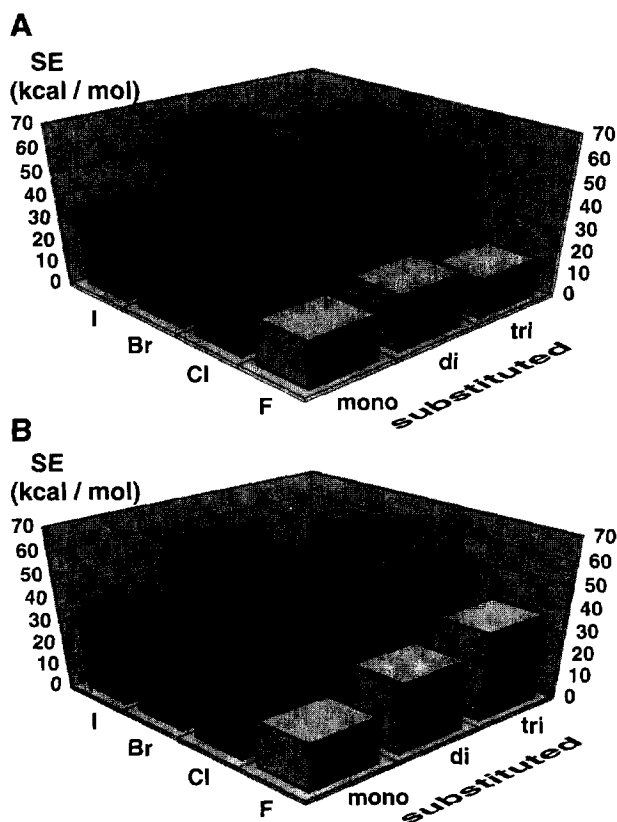

Fig. 7. Graphical representation of experimentally determined values of the stabilization energies SE (in kcal mol^{-1}) for the cations $X_n\text{CH}_3^{\oplus-n}$ ($X=\text{F}, \text{Cl}, \text{Br}, \text{I}$). Data shown in (A) are calculated according to the isodesmic reaction: $X_n\text{CH}_3^{\oplus-n} + \text{CH}_4 \rightarrow X_n\text{CH}_{4-n} + \text{CH}_3^{\oplus}$ according to $\Delta H_f(X_n\text{CH}_{4-n}) + \Delta H_f(\text{CH}_3^{\oplus}) - \Delta H_f(\text{CH}_4) - \Delta H_f(X_n\text{CH}_3^{\oplus-n})$. Data shown in (B) are calculated according to the isodesmic reaction: $X_n\text{CH}_3^{\oplus-n} + n\text{CH}_4 \rightarrow nX\text{CH}_3 + \text{CH}_3^{\oplus}$ according to $(n \cdot \Delta H_f(X_n\text{CH}_{4-n})) + \Delta H_f(\text{CH}_3^{\oplus}) - (n \cdot \Delta H_f(\text{CH}_4)) - \Delta H_f(X_n\text{CH}_3^{\oplus-n})$.

Although the general trend in each row of cations $X_n\text{CH}_3^{\oplus-n}$ (**84a–d**, $n=1$; **92a–d** $n=2$; **91a–c**, $n=3$) is not altered, i.e. iodo-substituted **84d** and **92d** or bromo-substituted **91c** ions are always more stable than the lighter homologues, the relative stability of the fluoro substituted cations **84a**, **92a** and **91a** is influenced. According to Eq. (10A), the $\text{F}_2\text{CH}^{\oplus}$ and $\text{F}_3\text{C}^{\oplus}$ ions are less stabilized than according to Eq. (10B) and indeed $\text{F}_3\text{C}^{\oplus}$ becomes even the least stable of all halocarbenium ions. This is possible, because the stabilities (large negative ΔH_f values) of the methanes F_2CH_2 and F_3CH employed in Eq. (10A) are considerably higher compared to the corresponding chloro, bromo and iodo methanes. The chloro-, bromo- and iodo-substituted ions show little variance in SE deduced from Eqs. (10A) and (10B). When Eq. (10B) is used to estimate the relative stability of halo-substituted carbene ions the effect of multiple fluoro-substitution on the stabilities of the fluoro-

methanes is eliminated and the tri-substituted ions are always the most stable for a given α -halogen center. As was repeatedly pointed out by theoretical chemists [26,59], such ground state effects have to be carefully considered, especially when electronic effects on the stability of one species are correlated with *SE*, which depends on all reaction partners. To shed more light on the complex electronic mechanisms of stabilizing carbocations, we have recalculated the structures of the tri-substituted cations X_3C^\oplus **91a–d** ($X = F, Cl, Br, I$) and choose the complexation energy, ΔH_c , with one molecule of water or ammonia as the criterion for the relative stability of these cations (Eqs. (11) and (12) and Table 4) [136].



These calculations might serve as a minimal model for the properties of X_3C^\oplus cations in solution and they were successfully applied by Frenking et al. in order to estimate the stability of silicenium ions R_3Si^\oplus [137]. The complexation energies are most negative for $X = F$ which indicates low stability of the F_3C^\oplus (**91a**) cation compared to Cl_3C^\oplus (**91b**), Br_3C^\oplus (**91c**) and I_3C^\oplus (**91d**) which have much lower complexation energies which is even positive for the $[Cl_3 \cdot H_2O]^+$ complex. These results are consistent with the ordering of *SE* deduced from Eqs. (10)A and B for these ions. They are, however, in contrast to findings obtained for the tri(chalco- geno)-substituted cations $(HX)_nCH_3^\oplus$ ($X = O, S, Se, Te$) where the cations bearing the most electronegative α -heteroatom – the oxocarbenium ions – were always the most stable within a given row [138]. In order to gain further insight into the electronic motifs of halocarbenium ions the total one electron charge density $\rho(r)$ and its Laplacian $\nabla^2\rho(r)$ was calculated. In Table 5 some topological properties of the Laplacian at the bond critical points r_b are listed.

For Cl_3C^\oplus and Br_3C^\oplus the charge densities ρ_b , Laplacians $\nabla^2\rho_b$ and energy densities $H(r_b)$ at the C–X bond critical points are negative. This shows the contraction of ρ towards the C–X bond path as was discussed in Section 6.1. As in $(HTe)_3C^\oplus$, the Laplace field $\nabla^2\rho(r)$ at the bond critical points of I_3C^\oplus is slightly positive while the energy density $H(r_b)$ is still negative and electronic charge ρ_b is accumulated (see for comparison Section 6.1, Table 2). This is an effect of the large atomic basin of the iodine atom in which the valence electrons are poorly localized. Remarkably, the Laplacian $\nabla^2\rho_b$ of F_3C^\oplus is very positive ($\nabla^2r_b = 0.312$ a.u.), too, which is in marked contrast to $(HO)_3C^\oplus$ where $\nabla^2\rho_b$ is strongly negative ($\nabla^2r_b = -0.367$ a.u.).

Table 4
Complexation energies in kcal/mol calculated according to Eqs. (11) and (12).^a

	F	Cl	Br	I
$\Delta H_c^{(H_2O)^b}$	–43.7	–10.9	–4.9	+0.6
$\Delta H_c^{(NH_3)}$	–79.65	–50.81	–50.36	–45.67

^a Calculated on the MP2 level. ^b See Ref. [136].

Table 5
Results of the topological analysis of the wave functions of X_3C^\oplus (X = F, Cl, Br, I)

C–X	r_{A-B} [Å]	r_b	ρ_b [e · Å ⁻³]	$\nabla^2 r$ [e · Å ⁻⁵]	$H(r_b)$ [Hartree · Å ⁻³]	ϵ_b
C–F	1.233	0.324	2.474	7.529	–3.905	0.006
C–Cl	1.648	0.471	1.754	–13.434	–1.574	0.080
C–Br	1.799	0.516	1.322	–2.071	–0.997	0.104
C–I	2.021	0.509	0.930	2.816	–0.541	0.092

r_{A-B} = C–X distance; r_b = location of the bond critical point given by the ratio of distances C–■/C–X; ρ_b = electron density at the bond critical point; $\nabla^2 r_b$ = value of the Laplacian at the bond critical point; $H(r_b)$ = energy density at the bond critical point; ϵ_b = ellipticity at the bond critical point [106].

Note that $(HO)_3C^\oplus$ is more stable than F_3C^\oplus by 100 kcal mol⁻¹ and it is the most stable of all chalcogeno-substituted carbenium ions, whereby F_3C^\oplus is the least stable among the halogeno-substituted carbenium ions! The decreasing stability of F_3C^\oplus is in accord with the very small ellipticity ϵ_b at the bond critical point, thus giving no indication of effective π -donation by the fluorine centers to compensate for σ -electron withdrawal. Obviously a minimum degree of π -donation as in $(HO)_3C^\oplus$ (also here ϵ_b is relatively small) is necessary to serve as an electron source to form a polar but well-localized bond in which electronic charge is concentrated. The high polarity of the C–F bond in F_3C^\oplus alone and resulting attractive electrostatic forces are less efficient in this respect. The negative energy density $H(r_b)$, however, leave no doubt about the highly polar but still covalent character of the C–F bond in this ion. One may interpret this observation in the way that although electronic charge is *accumulated* in the C–F binding region it is *concentrated* in the atomic basins of the highly electronegative fluorine atoms where the contribution of the potential energy to the total energy of the valence electrons is very high. A comparable observation is made for the F₂ and CF molecules where the Laplacian at the bond critical point is positive, too, but $H(r_b)$ is negative and the electronic charge ρ_b is much too high for a typical closed shell interaction as in Ar₂ [104,139].

A comparison of carbenium ions containing α -heteroelements from the higher periods of groups 16 and 17 leads to more consistent results. The trihalocarbenium ions X_3C^\oplus **91b–91d** (X = Cl, Br, I) are again generally less stable than their tri(chalcogeno)carbenium counterparts $(HX)_3C^\oplus$ (X = S, Se, Te). The decreasing stability of the halogeno-substituted ions correlates with the relatively low ellipticity ϵ_b of the C–X bonds at the bond critical points measuring the π -bond character. This is expected, because the energy gap ΔE between the formal acceptor atom C[⊕] and π -donor atom X increases when X is a group 17 element. Less π -bond character results for carbon halogen bonds (see Section 7.1). For Cl₃C[⊕], Br₃C[⊕] and I₃C[⊕] the ellipticity ϵ_b does not vary much and is largest for Br₃C[⊕]. Again it follows that, if resonance structures including C=X π -bonds are used to explain the relative stabilities of α -heteroatom substituted carbenium ions, the ones containing heteroatoms of the higher periods ($j > 2$) should be used.

7.2. Experimental results

In their pioneering work in 1966, Taft, Lampe and Martin determined the appearance potentials by electron impact of a series of halogen-substituted methanes [140]. From these data, the heats of formation of the ions XCH_2^{\oplus} ($X=F, Cl, Br, I$), X_2CH^{\oplus} ($X=F, Cl$) and X_3C^{\oplus} ($X=F, Cl$) were calculated. For the determination of the relative stabilization energies the hydride transfer reaction Eq. (10)A was used and the results are included in Fig. 7A. Within the series of tri-substituted ions, CF_3^{\oplus} is the least stable and in the series of mono-substituted ions, $BrCH_2^{\oplus}$ is the most stable ion in the gas phase. Beauchamp et al. performed an ion cyclotron resonance study of various non-interconverting isomeric ethylcations $C_2H_4X^{\oplus}$ and found in accordance with the theoretical results that for $X=Cl$ the acyclic ion **85b** is the most stable isomer (by $5.6 \text{ kcal mol}^{-1}$), while the cyclic bromonium ion **86c** is more stable by $1.4 \text{ kcal mol}^{-1}$ than acyclic **85c** [141]. Furthermore the determination of the direction of the exchange reaction Eq. (13)



allows an ordering of the influence of different substituents on the relative stability for *acyclic* α -heteroatom-substituted ethylcations, which was found to be $NH_2 > OH > PH_2 \approx SH > Br > Cl$. The stability of *cyclic* onium ions on the other hand follows the order $NH_2 > PH_2 \approx SH > Br > Cl > OH$.

Holmes, Lossing and McFarlane have determined the appearance potentials of almost the complete series of chloro-, bromo- and iodocarbonium ions $X_nCH_3^{\oplus-n}$ ($X=Cl, Br, I$; only I_3C^{\oplus} was not investigated) with energy selected electrons and their results were used to construct Fig. 7 [135]. The energy of the gas phase stretching vibration of the C–X bonds in XCH_2^{\oplus} ions ($X=F$: 1450 cm^{-1} ; $X=Cl$: 1040 cm^{-1} ; $X=Br$: 860 cm^{-1}) was deduced from photoelectron spectra of the corresponding radicals by Andrews et al. [142]. The C–X vibration is always considerably shifted to higher wavenumbers ($\Delta\nu(C-X)$: $X=F$: 287 cm^{-1} ; $X=Cl$: 214 cm^{-1} ; $X=Br$: 167 cm^{-1}) when compared to the C–X stretching fundamentals of the neutral radicals indicating substantial increase in net C–X bonding in all cations. The IR spectra of Cl_3C^{\oplus} and Cl_2CH^{\oplus} were recorded in matrix-isolation studies either by photolysis of chloroform [143] or by codeposition of Cl_3CH and SbF_5 on a SiC window at 77 K [144]. Using the latter procedure, Sunko et al. also generated $ClC(CH_2Cl)_2^{\oplus}$ from CH_2Cl_2 , which possesses not only a α -chloro center, but two chloro centers in the β -position to the central carbon atom. The degenerate stretching fundamentals of the C–Cl bonds in Cl_3C^{\oplus} were observed at about 1035 cm^{-1} and in Cl_2CH^{\oplus} at 1045 cm^{-1} (asymmetric) and 845 cm^{-1} (symmetric) which demonstrate considerable C–Cl bond strengthening in the cations in accordance with the gas phase studies. When hydrocarbons are codeposited with tetrachloromethane and SbF_5 the formation of carbocations *via* the first-formed Cl_3C^{\oplus} cation was observed at 150 K (Scheme 28) [144].

The precursor hydrocarbons **92a,b** are rearranged under these conditions to yield

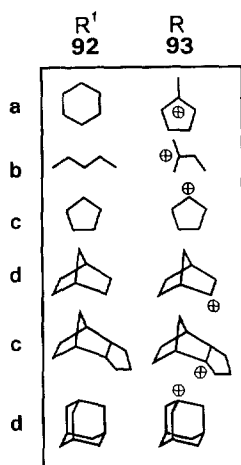
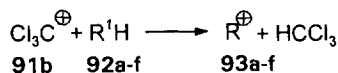
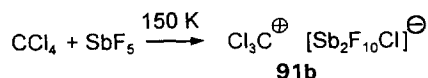

Scheme 28.

the tertiary carbenium ions **93a,b**. However, secondary carbocations **93c,d** could also be obtained, which indicates that $\text{Cl}_3\text{C}^{\oplus}$ is less stable according to the isodesmic reaction shown in Scheme 28 than alkylsubstituted carbenium ions. This was also predicted by calculations [134].

Under long-lived stable ion conditions, Olah and collaborators prepared a number of mono- and di-substituted halocarbenium ions, XCR_2^{\oplus} and $\text{X}_2\text{CR}^{\oplus}$, respectively [9,145–147]. Recently, this group succeeded in the preparation of the tri-substituted cations $\text{X}_3\text{C}^{\oplus}$ ($\text{X} = \text{F}, \text{Cl}, \text{Br}, \text{I}$) and undertook a combined theoretical and experimental study on their stability (Scheme 29) [148].

Although the trichlorosubstituted cation **91b** could be prepared by several different routes, all attempts to prepare the ion $\text{F}_3\text{C}^{\oplus}$ (**91a**) failed and formation of CF_4 was observed instead. The bromo and iodo analogues were obtained from the corresponding tetrahalomethanes and SbF_5 . All cations $\text{X}_3\text{C}^{\oplus}$ were characterized by ^{13}C NMR-spectroscopy. The trichloro carbenium ion **91b** is stable up to -50°C in SO_2ClF and coexists surprisingly in the presence of excess CCl_4 . The reaction with 3 equivalents of benzene leads cleanly to the tritylium ion $\text{Ph}_3\text{C}^{\oplus}$. The ^{13}C NMR chemical shift difference $\Delta\delta(^{13}\text{C})$ between the cation $\text{X}_3\text{C}^{\oplus}$ and corresponding methane X_3CH correlates linearly with the electronegativity of the halogen atom. A linear correlation between the ^{13}C resonances of the cations with calculated Mulliken charge densities residing on the carbon center was found as well. Based on these and previous results [9,146,147], it was concluded that the π -donation and charge-

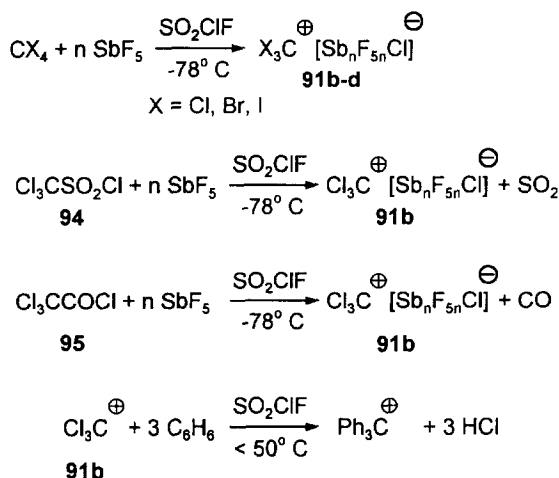

Scheme 29.

stabilizing effect on the thermodynamic stability of halomethyl cations follows the order $\text{F} > \text{Cl} > \text{Br} > \text{I}$. In contradiction to results from calculations, a poorer $2p(\pi) - np(\pi)$ overlap for $n > 2$ was assumed. Furthermore it was argued – again based on $\Delta\delta(^{13}\text{C})$ values obtained for cations XCMe_2^{\oplus} ($\text{X} = \text{F}, \text{Cl}, \text{Br}$) and $\text{Cl}_2\text{CMe}^{\oplus}$ – that π -donation per halogen ligand is diminished with increasing halogen substitution. Isodesmic reaction energies were not reported. Certainly the overlap argument is not valid to explain the stabilities of these cations. Furthermore, especially in the bromo and iodo compounds non-linear relativistic effects on the ^{13}C NMR shifts, which may be very different in the cations and methanes, admonish to be very cautious in discussion and correlating the NMR data with formal charges [149]. The π -donating ability of fluorine was mainly based on $^1\text{J}(^{19}\text{F}^{13}\text{C})$ coupling constants measured in various aryl- and diarylfluorocarbenium ions, which increase in systems where increasing π -backbonding was assumed [146, 147]. Again such data have to be treated with great care and should (as the ^{13}C NMR shifts) not be used to discuss bonding and stability in halo-substituted carbenium ions. The first X-ray crystal structure analysis of a chloro-substituted carbenium ion was reported by Laube et al. [17]. In the cation of the salt $[\text{ClC}(2\text{-Cl-C}_6\text{H}_4)\text{Ph}]^{\oplus} \text{SbF}_6^{\ominus}$ a shortened C–Cl bond length of 1.668 Å was observed which is about 4% shorter than the reference value of 1.734 Å of a $\text{C}(\text{sp}^2)\text{-Cl}$ bond, but is still considerably longer than the calculated value for ClCH_2^{\oplus} (1.588 Å) [59]. This is due to considerable conjugation of the central carbon atom with the aryl rings, which are twisted out of plane by 16° and 41° . The C–Cl bond shortening may nevertheless be taken as an indication of partial $\text{C}=\text{Cl}$ π -bonding. Structures of amino-substituted halocarbenium ions, $(\text{R}_2\text{N})\text{ICH}^{\oplus}$ [150] and $(\text{Me}_2\text{N})_2\text{ClC}^{\oplus}$ [139] are known but these are better described as 2-halo-substituted iminium ions with short $\text{N}=\text{C}$ bonds and C–X single bonds ($\text{X} = \text{Cl}, \text{I}$).

8. Conclusions

The present article has mainly focused on the question on how α -heteroelements stabilize a carbenium ion. Many research groups have collected experimental and theoretical data over the last thirty years in order to find contexts between the relative stability and chemical bonding in these ions. This led to a numerous amount of compounds $X_nCR_3^{\oplus-n}$ in which X stands for an atom of almost all main group elements. A graphical presentation of stabilization energies SE is shown in Fig. 8.

Although numbers obtained from isodermic reactions have to be treated with great care, some conclusions can be drawn.

(1) All α -heteroelements from groups 1, 2, and 13 to 17 stabilize a carbenium ion with respect to the parent methenium CH_3^{\oplus} ! These heteroelements rank from the most electropositive elements, the alkali metals, to the most electronegative element, fluorine.

(2) Resonance structures like those shown in Scheme 1 are often used to explain the stability of these ions. The stability of carbenium ions substituted by alkali or alkaline earth metals is indeed easily explained by assuming positive σ -charge transfer from the electropositive metal centers to the C^{\oplus} center. The larger the electro-

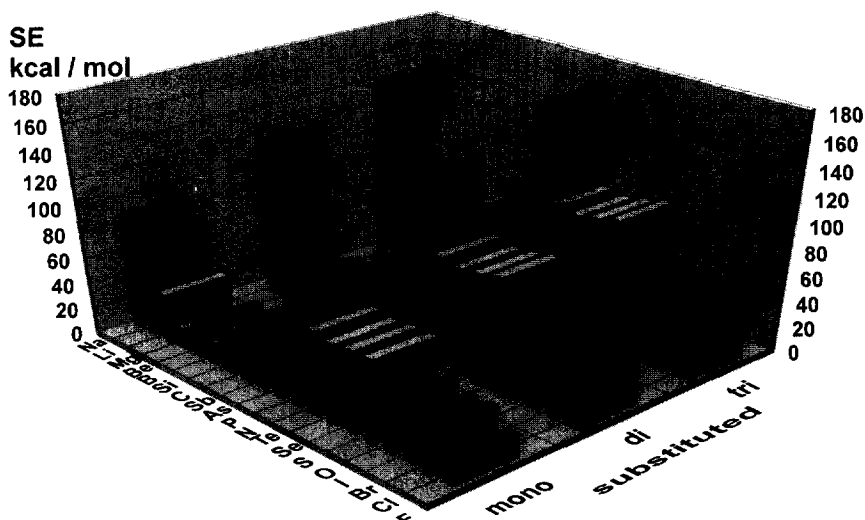

Fig. 8. Graphical representation of computational determined values for the stabilization energies SE (in kcal mol^{-1}) of mono, di and tri-substituted cations $H_{3-n}C(XH_m)_n^{\oplus}$. SE was calculated either according to the isodesmic reaction (A): $H_{3-n}C(XH_m)_n^{\oplus} + CH_4 \rightarrow H_{4-n}C(XH_m)_n + CH_3^{\oplus}$ (for X = halogens, chalcogens, C, Li) or according to the isodesmic reaction (B): $H_{3-n}C(XH_m)_n^{\oplus} + nCH_4 \rightarrow nH_3CXH_m + CH_3^{\oplus}$ for (X = N and P), which are identical for $n=1$. The values are listed for mono-, di- and tri-substituted carbocations, respectively. F: 17.96 [59], 34.12 [70], 17.40 [136]; Cl: 31.30 [59], 43.54 [70], 41.80 [136]; Br: 31.81 [59], 44.91 [70], 53.60 [136]; I: 38.14 [59], 49.11 [70], 62.00 [136]; O: 63.64, 88.91, 100.62; S: 63.48, 85.49, 97.00; Se: 61.88, 83.87, 94.46; Te: 64.59, 87.51, 97.09 [98]; N: 95.00, 139.30, 166.40 [58]; P: 63.00, 75.00 [70]; As: 50.68; Sb: 45.19 [59]; C: 29.50, 51.20, 67.80 [27]; Si: 17.80; B: 26.20; Al: 27.40; Be: 16.30; Mg: 38.30 [29]; Li: 77.00, 124.00, 145.00 [27]; Na: 88.7 [29].

negativity difference between the carbon and metal center the more stable the ion which is reflected by the increasing stability within the row $(\text{HBe})\text{CH}_2^\oplus < (\text{HMg})\text{CH}_2^\oplus < \text{LiCH}_2^\oplus < \text{NaCH}_2^\oplus$ (see Fig. 1 for electronegativity differences $\Delta\chi$). As well, the increasing stability with increasing metal substitution is expected and found in the row $\text{LiCH}_2^\oplus < \text{Li}_2\text{CH}^\oplus < \text{Li}_3\text{C}^\oplus$. Note however that $\text{Li}_3\text{C}^\oplus$ undergoes Jahn–Teller-distortion from D_{3h} symmetry to a C_{2v} triplet ground state.

(3) There are some further properties of the carbenium ions which can be correlated with the electronegativity of the α -heteroelement as was repeatedly demonstrated by Schleyer et al. [29, 59]. For instance the H–C–H angle in mono-substituted carbenium ions XCH_2^\oplus varies linearly with the electronegativity of the X center. In accord with the VSEPD-model [151], this angle is small ($< 107^\circ$) for X = Li while it is large for X = F (125°).

(4) Beginning with substituents containing heteroatoms from group 13 in the α -position to the central carbon atom the stabilizing mechanisms become more complex and cannot be attributed to one mechanism alone. For X = BH_2 , SiH_3 and CH_3 the most important contribution to the stability comes from positive hyperconjugation (expressed by no-bond resonance structures $\text{H}^\oplus \text{X}=\text{CH}_2 \leftrightarrow \text{H}-\text{X}-\text{CH}_2^\oplus$). This can be seen by the very different stabilities of different conformers of $(\text{H}_2\text{B})\text{CH}_2^\oplus$ (isomer with H_2B orthogonal to CH_2 being more stable than planar isomer) and the stability ordering $(\text{H}_3\text{Si})\text{CH}_2^\oplus < (\text{H}_3\text{C})\text{CH}_2^\oplus$. On the other hand both conformers of $(\text{H}_2\text{Al})\text{CH}_2^\oplus$ have almost the same stability and are as stable as $\text{H}_2\text{BCH}_2^\oplus$ and this demonstrates the importance of σ -induction by the electropositive H_2Al group.

(5) Charge transfer by π -donation is assumed to stabilize a carbenium ion when the α -heteroatom is equipped with a lone pair of electrons which is found in all common substituents incorporating a heteroelement from group 15 or higher. Indeed, the guanidinium ion $(\text{H}_2\text{N})_3\text{C}^\oplus$ is the most stable carbenium ion with respect to CH_3^\oplus . It is therefore not surprising that it is found to fulfill important biological functions. Regarding the decrease of stability of phosphorus-substituted carbenium ions $(\text{H}_2\text{P})_n\text{CH}_3^\oplus$ when compared to nitrogen analogues seemingly confirms the often made assumption that elements from the higher periods are generally worse π -donors. However, calculations [59] proved this to be false and the decrease in stability in the series of mono-substituted carbenium ions $(\text{H}_2\text{X})\text{CH}_2^\oplus$ (X = N, P, As, Sb) is due to an increase in energy needed for planarization of the H_2X group which is required to allow effective π -donation. When the planarization energies are taken into account, π -donor centers from the higher periods are as good as second period elements!

(6) Furthermore, it is assumed that electronegative substituents destabilize a carbenium ion and this effect is then overcompensated by π -donation to account for the stability. These arguments were often used to explain the relative stabilities of α -chalcogeno substituted carbenium ions $(\text{HX})_n\text{CH}_3^\oplus$. As was pointed out above, this assumption is not supported by results from quantum mechanical calculations, which either rely on population analysis or on properties of the total electron density ρ itself (Laplacians). It turns out, that sulfur, selenium and tellurium heteroatoms are even slightly better π -donors than oxygen. This is seen, for example, by the

higher ellipticities ϵ_b of the electron density at the C–X bond critical points, which can be taken as a measure of the π -bond character. On the other hand, the high stability of oxy-carbenium ions, which increases with increasing number of RO substituents is caused by the short and highly polar $C^{\delta+}-O^{\delta-}$ bonds. That bond polarity causes high binding energies and formation enthalpies due to Coulomb attractions is trivial and a crucial part of resonance theory. It is therefore a priori not correct to assume that formally electron deficient species are generally destabilized by electron withdrawing substituents. In fact, attractive Coulomb forces contribute significantly to the stability of all α -heteroatom substituted carbenium ions with respect to CH_3^{\oplus} . However, in relation to other stabilizing electronic effects, attractive electrostatic $C^{\delta+}-X^{\delta-}$ interactions are most pronounced in nitrogen-, oxygen- and even fluorine-substituted carbenium ions, while π -donation is a dominant stabilizing factor in ions containing corresponding heteroelements from the higher periods.

(7) However, when the relative stabilities of $(H_2N)_3C^{\oplus} > (HO)_3C^{\oplus} \gg F_3C^{\oplus}$ are compared (which decrease rapidly) it becomes clear that the high polarity of the C–X bond alone (X = N, O, F), which increases along this row, is not sufficient to evoke large stabilization either. Again the topological analysis of the Laplacians $-\nabla^2\rho_b$ might give valuable information about the differences and similarities concerning C–X bonding in these ions. Although the ellipticities of the C–X bonds in $(H_2N)_3C^{\oplus}$, $(HO)_3C^{\oplus}$ and F_3C^{\oplus} are quite small when compared with their homologues (i.e. X = P–Sb, S–Te, Cl–I) it decreases even further from 0.199 in $(H_2N)_3C^{\oplus}$ to 0.042 in $(HO)_3C^{\oplus}$ to only 0.006 in F_3C^{\oplus} ($\epsilon_b = 0.0$ for a pure σ -bond and $\epsilon_b = 0.399$ in ethylene). When the energy densities $H(r_b)$ at the bond critical points are regarded – which can be correlated with the σ -binding energies – the expected decrease with increasing electronegativity is seen when $(H_2N)_3C^{\oplus}$ is compared with $(HO)_3C^{\oplus}$. However, F_3C^{\oplus} shows the highest $H(r_b)$ value among the ions containing a second period α -heteroatom which is caused by a relatively high kinetic energy of the electrons (poor localization) at the bond critical points. It may be therefore stated, that π -donation from the heteroatom to the carbon center serves as a mechanism to concentrate sufficient charge in the C–X binding region in order to form a highly polar but localized bond and it is in this sense that π -donation is important in second period heteroatom substituted carbenium ions.

(8) The stability of a species is obtained by summation over the energy of all occupied molecular orbitals and the squares of these orbitals can be correlated with the electron density. Therefore, we feel that the discussion of the relative stabilities of carbenium ions in terms of analyzing properties of their total electron densities is appropriate. However, it must be taken into account that the stabilization energies themselves obtained by isodesmic reactions may be problematic because of the ground state effects of species involved in the reaction.

(9) Various experimental methods became known to synthesize stable α -heteroatom substituted carbenium ions. The chemistry of carbenium ions containing the heteroelements from the higher periods was most extensively explored and will be even more so in the future. The C–X bond polarity is reflected in many chemical transformations, i.e. carbon is attacked by nucleophiles in nitrogen-,

oxygen- and halogen-substituted carbenium ions while the heteroelement X is the center of attack, when it is less electronegative than carbon. Many useful synthetic applications have already been developed especially in heterocyclic chemistry. The applications of these carbenium ions in synthetic chemistry can and will be considerably extended by making use of Olah's concept of superelectrophilic activation.

(10) Physical properties of α -heteroatom substituted carbenium ions may become interesting as well. Applications for optical uses can be envisioned since polarizable heteroatoms like selenium or tellurium can be incorporated and the ions remain very stable. Like triarylmethenium ions, a wide range of different colored species can be prepared. However in contrast to these, in α -heteroatom substituted carbenium ions like in the orange seleno- or violet telluro-carbenium ions, the counter-anion forms tight contact ion pairs easily, which might be used for the synthesis of charge-transfer salts in order to tune the physical properties even further.

Much experimental and theoretical material has been collected during the last 40 years over a wide range of compounds, which allows for the discussion of many aspects of chemical bonding in electronically very different compounds (σ - and π -bonding, covalent and ionic bonds, well established and modern bonding theories) and reactivity (substitutions, cycloadditions, charge and orbital controlled processes, electron transfer). We can still learn much more and the carbenium-vehicle with the trigonal planar CX_3^{\oplus} star keeps on rolling into chemistry of excellence.

Acknowledgements

This work was supported by the Deutsche Forschungsgemeinschaft, the Schweizerischen Nationalfond and the Hoechst AG. We thank Prof. Rainer Glaser, Dr. Grace S. Chen, S. Fau and Prof. G. Frenking for very valuable discussions and making results accessible prior to publication. We thank J. Meienberger for numerous literature researches.

References

- [1] J.F. Norris, W.W. Saunders, *J. Am. Chem. Soc.* 25 (1901) 54.
- [2] F. Kehrman, F. Wentzel, *Chem. Ber.* 24 (1901) 3815.
- [3] A.v. Baeyer, V. Villiger, *Chem. Ber.* 34 (1902) 1189.
- [4] H. Meerwein, K.v. Emster, *Chem. Ber.* 55 (1922) 2500.
- [5] F.C. Whitmore, *J. Am. Chem. Soc.* 54 (1932) 3274.
- [6] C.K. Ingold, *Structure and Mechanism in Organic Chemistry*, Cornell University Press, Ithaca, 1969.
- [7] For a review, see: G.A. Olah, *Angew. Chem. Int. Ed.* 12 (1973) 173.
- [8] G.A. Olah, G.K. Surya, J. Sommer, *Superacids*, Wiley, New York, 1985.
- [9] G.A. Olah, P.v.R. Schleyer, in: P.v.R. Schleyer (Ed.), *Carbonium Ions*, vols. I–V, Wiley, New York, 1976.
- [10] T.T. Tidwell, *Angew. Chem. Int. Ed.* 23 (1984) 20.
- [11] P. Vogel, *Carbocation Chemistry*, Elsevier, Amsterdam, 1985.

- [12] M. Hanack, in: M. Hanack (Ed.), *Methoden der Organischen Chemie*, Houben–Weyl, Bd. E19c, Thieme, Stuttgart, 1990.
- [13] M. Saunders, H.A. Jimenez-Vásquez, *Chem. Rev.* 91 (1991) 375.
- [14] P. Buzek, P.v.R. Schleyer, S. Sieber, *Chemie in unserer Zeit* 26 (1992) 116.
- [15] G.A. Olah, *Angew. Chem. Int. Ed. Engl.* 32 (1993) 767.
- [16] G.A. Olah, *Angew. Chem. Int. Ed. Engl.* 34 (1995) 1393.
- [17] T. Laube, E. Bannwart, S. Hollenstein, *J. Am. Chem. Soc.* 115 (1993) 1731.
- [18] For a review, see: K. Lammertsma, P.v.R. Schleyer, H. Schwarz, *Angew. Chem. Int. Ed. Engl.* 28 (1989) 1321.
- [19] H. Bock, K. Ruppert, C. Näther, Z. Havlas, H.F. Herrmann, C. Arad, I. Göbel, A. John, J. Meuret, S. Nick, A. Rauschenbach, W. Seitz, T. Vaupel, B. Solouki, *Angew. Chem. Int. Ed. Engl.* 31 (1992) 550.
- [20] For a review, see: C.U. Pittman Jr., S.M. Manus, J.W. Larsen, *Chem. Rev.* 72 (1972) 357.
- [21] For a review, see: J.P. Marino, in: A. Senning (Ed.), *Topics in Sulfur Chemistry*, vol. 1, Thieme, Stuttgart, 1976, p. 1.
- [22] D. Lenior, H.-U. Siehl, in: M. Hanack (Ed.), *Methoden der Organischen Chemie*, Houben–Weyl, Bd. E19c, Thieme, Stuttgart, 1990, p. 290 ff.
- [23] J. Hocker, F. Jonas, in: M. Hanack (Ed.), *Methoden der Organischen Chemie*, Houben–Weyl, Bd. E19c, Thieme, Stuttgart, 1990, p. 679.
- [24] T. Okayama, in: S. Oae (Ed.), *Rev. Heteroatom Chem.*, vol. 1, MYU, Tokyo, 1988, p. 46.
- [25] L.C. Allen, *J. Am. Chem. Soc.* 111 (1989) 9003.
- [26] Y. Apeloig, M. Karni, *J. Chem. Soc. Perkin Trans. II* (1988) 625.
- [27] J. Chandrasekhar, J.A. Pople, R. Seeger, U. Seeger, P.v.R. Schleyer, *J. Am. Chem. Soc.* 104 (1982) 3651.
- [28] P.v.R. Schleyer, B. Tidor, E.D. Jemmins, J. Chandrasekhar, E.-U. Würthwein, A.J. Kos, B.T. Luke, J.A. Pople, *J. Am. Chem. Soc.* 105 (1983) 484.
- [29] For a review, see: P.v.R. Schleyer, *Pure and Appl. Chem.* 59 (1987) 1647.
- [30] J.C. White, R.J. Cave, E.R. Davidson, *J. Am. Chem. Soc.* 110 (1988) 6308.
- [31] S. Hollenstein, T. Laube, *J. Am. Chem. Soc.* 115 (1993) 7241.
- [32] C.H. Wu, H.R. Ihle, *Chem. Phys. Lett.* 61 (1979) 54.
- [33] R. Weiss, C. Priesner, H. Wolf, *Angew. Chem. Int. Ed. Engl.* 17 (1978) 446.
- [34] For some weakly coordinated anions, see: Z. Xie, T. Jelinek, R. Bau, C.A. Reed, *J. Am. Chem. Soc.* 116 (1994) 1907 and references therein.
- [35] A. Igau, H. Grützmacher, A. Bacereido, G. Bertrand, *J. Am. Chem. Soc.* 110 (1988) 6463.
- [36] A.J. Arduengo III, J.R. Görlich, W.J. Marshall, *J. Am. Chem. Soc.* 117 (1995) 11027.
- [37] H. Tomioka, T. Watanabe, K. Hirai, K. Furukawa, T. Takui, K. Itoh, *J. Am. Chem. Soc.* 117 (1995) 6376.
- [38] A.J. Arduengo III, S.F. Gamper, J.C. Calabrese, F. Davidson, *J. Am. Chem. Soc.* 116 (1994) 4391.
- [39] A.J. Arduengo, H.V. Rasika Dias, F. Davidson, R.L. Harlow, *J. Organomet. Chem.* 462 (1993) 13.
- [40] A.M. Aissani, J.C. Baum, R.F. Langler, J.L. Ginsburg, *Can. J. Chem.* 64 (1986) 532.
- [41] M.K. Murphy, J.L. Beauchamp, *J. Am. Chem. Soc.* 98 (1976) 1433.
- [42] A. Berndt, *Angew. Chem. Int. Ed. Engl.* 32 (1993) 985.
- [43] G. Bertrand, R. Reed, *Coord. Chem. Rev.* 137 (1994) 323.
- [44] N. Kuhn, G. Henkel, T. Kratz, J. Kruetzberg, R. Boese, A.H. Maulitz, *Chem. Ber.* 126 (1993) 2041 and references therein.
- [45] For a review, see: J.L. Lambert, *Tetrahedron* 46 (1990) 2677.
- [46] S.G. Wierschke, J. Chandrasekhar, W.L. Jørgensen, *J. Am. Chem. Soc.* 107 (1985) 1496.
- [47] F.K. Cartledge, J.P. Jones, *Tetrahedron Lett.* (1971) 2193.
- [48] P.J. Stang, M. Ladika, Y. Apeloig, A. Stanger, M.D. Schiavelli, M.R. Hughey, *J. Am. Chem. Soc.* 104 (1982) 6852.
- [49] G.A. Olah, A.L. Berrier, L.D. Field, G.K.S. Prakash, *J. Am. Chem. Soc.* 104 (1982) 1349.
- [50] J.A. Soderquist, A. Hassner, *Tetrahedron Lett.* 29 (1988) 1899.
- [51] For example, see: R.A. Volkmann, in: B.M. Trost, I. Fleming, S.L. Schreiber (Eds.), *Comprehensive Organic Synthesis*, vol. 1, Pergamon Press, Oxford, 1991, p. 355.

- [52] For example, see: E.F. Kleinman, H. Heaney, R.A. Volkmann, L.A. Overman, D.J. Ricca, H. Hiemstra, W.N. Speckamp, I. Ugi, S. Lohberger, R. Karl, in: B.M. Trost, I. Fleming, S.L. Schreiber (Eds.), *Comprehensive Organic Synthesis*, vol. 2, Pergamon Press, Oxford, 1991, p. 893.
- [53] For example, see: A. Ehmman, R. Gompper, H. Hartmann, T.J.J. Müller, K. Polborn, R. Schütz, *Angew. Chem. Int. Ed. Engl.* 33 (1994) 572.
- [54] F. Bernardi, I.G. Csizmada, N.D. Epiotis, *Tetrahedron* 31 (1975) 3085.
- [55] F. Bernardi, A. Bottoni, A. Venturini, *J. Am. Chem. Soc.* 108 (1986) 5395.
- [56] C.F. Rodriguez, A.C. Hopkinson, *J. Mol. Struct. (THEOCHEM)* 152 (1987) 55.
- [57] D. Bond, *J. Am. Chem. Soc.* 113 (1991) 385.
- [58] A. Gobbi, G. Frenking, *J. Am. Chem. Soc.* 115 (1993) 2362.
- [59] J. Kapp, C. Schade, A.M. El-Nahas, P.v.R. Schleyer, *Angew. Chem.* 108 (1996) 2373.
- [60] R.W. Taft, R.H. Martin, F.W. Lampe, *J. Am. Chem. Soc.* 87 (1965) 2490.
- [61] W. Kutzelnigg, *Angew. Chem. Int. Ed. Engl.* 23 (1984) 272.
- [62] M.W. Schmidt, P.N. Truong, M.S. Gordon, *J. Am. Chem. Soc.* 109 (1987) 5217.
- [63] L.L. Lohr, H.B. Schlegel, K. Morokuma, *J. Phys. Chem.* 88 (1984) 1981.
- [64] C. Schade, P.v.R. Schleyer, *J. Chem. Soc. Chem. Commun.* (1987) 1399.
- [65] M. Ehrig, H. Horn, C. Kölmel, R. Ahlrichs, *J. Am. Chem. Soc.* 113 (1991) 3701.
- [66] D.A. Dixon, K.D. Dobbs, A.J. Arduengo III, G. Bertrand, *J. Am. Chem. Soc.* 113 (1991) 8782.
- [67] D.C. Pestana, P.P. Power, *J. Am. Chem. Soc.* 113 (1991) 8426.
- [68] H. Horn, R. Ahlrichs, *J. Am. Chem. Soc.* 112 (1990) 2121.
- [69] A. Gobbi, P.J. MacDougall, G. Frenking, *Angew. Chem. Int. Ed. Engl.* 30 (1991) 1001.
- [70] C. Marchand, H. Grützmacher, unpublished results.
- [71] H. Grützmacher, H. Pritzkow, *Angew. Chem. Int. Ed. Engl.* 28 (1989) 740.
- [72] pK_a (NH_3^+): 9.25; pK_a (MeNH_3^+): 10.66; pK_a [$(\text{H}_2\text{N})_3\text{C}^+$]: 13.6; S.J. Angyal, W.K. Warburton, *J. Chem. Soc.* (1951) 2492.
- [73] A. Terfort, G.v. Kiedrowski, *Angew. Chem. Int. Ed. Engl.* 31 (1992) 654.
- [74] A. Berkessel, R.K. Thauer, *Angew. Chem. Int. Ed. Engl.* 34 (1995) 2247.
- [75] G.A. Olah, N. Hartz, G. Rasul, G.K. Surya Prakash, *J. Am. Chem. Soc.* 117 (1995) 1336.
- [76] H. Hogeveen, C.J. Gaasbeek, *Recl. Trav. Chim. Pays-Bas* 87 (1968) 319.
- [77] T.v.d. Knaap, F. Bickelhaupt, *Tetrahedron Lett.* 23 (1982) 2037.
- [78] H. Grützmacher, H. Pritzkow, *Angew. Chem. Int. Ed. Engl.* 30 (1991) 709.
- [79] H. Grützmacher, H. Pritzkow, *Angew. Chem. Int. Ed. Engl.* 31 (1992) 99.
- [80] U. Heim, H. Pritzkow, H. Schönberg, H. Grützmacher, *J. Chem. Soc. Chem. Commun.* (1993) 673.
- [81] O.I. Kolodiaznyy, *Z. Chem.* 29 (1989) 396 and references therein.
- [82] G.A. Olah, T.W. Westerman, *J. Am. Chem. Soc.* 95 (1973) 7530.
- [83] A. Igau, A. Bacereido, H. Grützmacher, H. Pritzkow, G. Bertrand, *J. Am. Chem. Soc.* 111 (1989) 6853.
- [84] U. Heim, Dissertation, Heidelberg, 1992.
- [85] J. Thomaier, G. Alcaraz, H. Hillebrecht, H. Grützmacher, *J. Organomet. Chem.* in press.
- [86] N. Wiberg, M. Link, G. Fischer, *Chem. Ber.* 122 (1989) 409.
- [87] U. Heim, H. Pritzkow, U. Fleischer, H. Grützmacher, *Angew. Chem. Int. Ed. Engl.* 32 (1993) 1359.
- [88] G. Fodor, S. Nagubandi, *Tetrahedron* 36 (1980) 1279.
- [89] U. Heim, H. Pritzkow, U. Fleischer, H. Grützmacher, M. Sanchez, R. Reau, G. Bertrand, *Chem. Eur. J.* 2 (1996) 68.
- [90] U. Heim, H. Grützmacher, unpublished results. NMR data of **45a**, **b** are given below: **45a**: ^1H NMR (CDCl_3 , 300 K, 89.55 MHz): δ = 0.41 (s, 18 H, SiCH_3), 0.96 (d, $^2J_{\text{PH}} = 20.7$ Hz, 1 H, CHSi_2), 1.47 (d, $^3J_{\text{PH}} = 18.9$ Hz, 9 H, CCH_3), 1.98 (s, 3 H, CH_3), 2.61–3.50 (m, 2.5 H, CH_2 and PH^*), 5.23 (m, 2 H, $=\text{CH}_2$), 5.52 (d, $^1J_{\text{PH}} = 450$ Hz, PH^*). *50% of the PH -resonance is covered by the multiplett of the CH_2 -group while the remaining 50% are seen as a complex multiplett centered at 8.35 ppm. ^{13}C NMR (CDCl_3 , 300 K, 22.49 MHz): δ = 1.3 (d, $^3J_{\text{PC}} = 2.9$ Hz, SiCH_3), 1.5 (d, $^1J_{\text{PC}} = 14.6$ Hz, CHSi_2), 3.5 (d, $^3J_{\text{PC}} = 2.9$ Hz, SiCH_3), 23.4 (d, $^3J_{\text{PC}} = 3.0$ Hz, CH_3), 26.6 (s, CCH_3), 28.7 (d, $^1J_{\text{PC}} = 42.5$ Hz, CH_2), 32.8 (d, $^1J_{\text{PC}} = 39.6$ Hz, CCH_3), 120.8 (d, $^3J_{\text{PC}} = 10.6$ Hz, $\text{C}=\text{CH}_2$), 134.2 (d, $^2J_{\text{CH}} = 8.8$ Hz, $\text{C}=\text{CH}_2$). ^{31}P NMR (CDCl_3 , 300 K, 36.28 MHz): δ = 30.5 (d, $^1J_{\text{PH}} = 447$ Hz). ^{29}Si NMR (CD_2Cl_2 , 300 K, 39.76 MHz): δ = 6.2 (d, $^2J_{\text{PSi}} = 5.5$ Hz), 9.9 (d,

$^2J_{\text{P}_{\text{Si}}}$ = 6.1 Hz). ^{27}Al NMR (CDCl_3 , 300 K,): * = 102.7. **45b**: ^1H NMR (CDCl_3 , 300 K, 200.133 MHz): * = 0.26 (s, 9 H, SiCH_3), 1.20 (d, $^3J_{\text{PH}}$ = 18.0 Hz, 9 H, CCH_3), 2.01 (s, 3 H, CH_3), 3.24 (m, 2 H, CH_2), 3.36 (dd, $^2J_{\text{PH}}$ = 19.8 Hz, $^3J_{\text{HPH}}$ = 11.5 Hz, 1 H, CHSiPh), 5.27 (m, 2.5 H, $=\text{CH}_2$ and PH^*), 6.41 (d, $^1J_{\text{PH}}$ = 457 Hz, PH^*), 7.32 (m, 5H, arom. CH). *50% of the PH-resonance is covered by the multiplett of the CH_2 -group while the remaining 50% are seen as a complex multiplett centered at 7.55 ppm. ^{13}C NMR (CDCl_3 , 300 K, 50.323 MHz): * = -0.5 (s, SiCH_3), 23.7 (d, $^3J_{\text{PC}}$ = 4.7 Hz, CH_3), 26.1 (d, $^1J_{\text{PC}}$ = 13.3 Hz, CHSiPh), 26.5 (s, CCH_3), 27.1 (d, $^1J_{\text{PC}}$ = 41.0 Hz, CH_2), 33.9 (d, $^1J_{\text{PC}}$ = 37.0 Hz, CCH_3), 119.8 (d, $^3J_{\text{PC}}$ = 9.7 Hz, $\text{C}=\text{CH}_2$), 128.0 (s, *p*-Carom.), 129.2 (d, $^3J_{\text{PC}}$ = 6.5 Hz, *o*-Carom), 130.1 (s, *m*-Carom) 132.0 (d, $^2J_{\text{PC}}$ = 8.1 Hz, *ipso*-Carom) 133.7 (d, $^2J_{\text{PC}}$ = 8.6 Hz, $\text{C}=\text{CH}_2$). ^{31}P NMR (CDCl_3 , 300 K, 81.012 MHz): * = 21.5 (dm, $^1J_{\text{PH}}$ = 457 Hz). ^{29}Si NMR (CDCl_3 , 300 K, 39.76 MHz): * = 9.1 (d, $^2J_{\text{P}_{\text{Si}}}$ = 3.2 Hz).

- [91] For a review, see: P.J. Davidson, M.F. Lappert, R. Pearce, Chem. Rev. 76 (1976) 19.
 [92] For a review, see: R.R. Schrock, G.W. Parshall, Chem. Rev. 76 (1976) 243.
 [93] N. Wiberg, G. Fischer, S. Wagner, Chem. Ber. 124 (1991) 769.
 [94] F. Bernardi, I.G. Czimadia, H.B. Schlegel, S. Wolfe, Can. J. Chem. 53 (1975) 1144.
 [95] F. Bernardi, A. Magini, N.D. Epiotis, J.R. Larson, S. Shaik, J. Am. Chem. Soc. 99 (1977) 7465.
 [96] F. Bernardi, A. Bottoni, N.D. Epiotis, J. Am. Chem. Soc. 100 (1978) 7205.
 [97] P.G. Jasien, W.J. Stevens, J. Chem. Phys. 83 (1985) 2984.
 [98] G.S. Chen, C.M. Marchand, D. Farmer, R. Glaser, H. Grützmacher, submitted for publication.
 [99] L. Hevesi, S. Desauvage, B. Georges, G. Evrad, P. Blanpain, A. Michel, S. Harkema, G.J.v. Hummel, J. Am. Chem. Soc. 106 (1984) 3784.
 [100] S.G. Lias, J.E. Bartmess, J.F. Liebman, J.L. Holmes, R.D. Levin, W.G. Mallard, J. Phys. Chem. Ref. Data, Suppl. 1 (1988).
 [101] G. Modena, G. Scorrano, P. Venturello, J. Chem. Soc. Perkin Trans. II (1979) 1 and references therein.
 [102] J.K. Pau, M.B. Ruggera, J.K. Kim, M.C. Caserio, J. Am. Chem. Soc. 100 (1978) 4242.
 [103] H. Grützmacher, D. Ohlmann, C.M. Marchand, G.S. Chen, D. Farmer, R. Glaser, A. Currao, R. Nesper, H. Pritzkow, Angew. Chem. Int. Ed. Engl. 35 (1996) 300.
 [104] R. Bader, Atoms in Molecules. A Quantum Theory, Oxford University Press, New York, 1990.
 [105] P.L.A. Popelier, Comput. Phys. Commun. 93 (1996) 212.
 [106] D. Cremer, E. Kraka, Angew. Chem. 96 (1984) 612.
 [107] F. Klages, E. Zange, Chem. Ber. 92 (1959) 1828.
 [108] H. Meerwein, K. Bodenbrenner, P. Borner, F. Kunert, K. Wunderlich, Justus Liebigs Ann. Chem. 632 (1960) 38.
 [109] Optimized procedure: U. Pindur, C. Flo, Synth. Commun. 19 (1989) 2307.
 [110] G.A. Olah, A.M. White, J. Am. Chem. Soc. 90 (1968) 1884.
 [111] T. Okuyama, T. Fueno, J. Am. Chem. Soc. 112 (1980) 6591 and references therein.
 [112] H. Ishibashi, M. Ikeda, in: S. Oae (Ed.), Reviews on Heteroatom Chemistry, vol. 7, MYU, Tokyo, 1992, p. 191.
 [113] H. Ishibashi, M. Ikeda, in: S. Oae (Ed.), Rev. Heteroatom Chemistry, vol. 14, MYU, Tokyo, 1996, p. 59.
 [114] I. Stahl, I. Kühn, Chem. Ber. 116 (1983) 1739.
 [115] L. Hevesi, in: S. Patai, Z. Rappoport (Eds.), The Chemistry of Organic Selenium and Tellurium Compounds, vol. 1, Wiley, New York, 1986, p. 307.
 [116] R.A. McClelland, M. Leung, J. Org. Chem. 45 (1980) 187.
 [117] H. Wautier, S. Desauvage, L. Hevesi, J. Chem. Soc. Chem. Commun. (1981) 738.
 [118] D. Ohlmann, Dissertation, Freiburg, 1996.
 [119] For a stable 2-telluroimidazole and related compounds, see: N. Kuhn, G. Henkel, T. Kratz, Chem. Ber. 126 (1993) 2047.
 [120] For a recent report on bis(telluro)methanes, see: R.W. Hoffmann, R.K. Dress, T. Ruhland, A. Wenzel, Chem. Ber. 128 (1995) 861.
 [121] Pioneering work: D. Seebach, A.K. Beck, Chem. Ber. 108 (1975) 314.
 [122] D. Ohlmann, H. Grützmacher, unpublished results.
 [123] M.R. Caira, J.F. De Wet, Acta Cryst. B37 (1981) 709.

- [124] H. Paulsen, R. Dammeyer, *Chem. Ber.* 106 (1973) 2324.
- [125] L.O. Atovmyan, I. Ponomarev, *Zh. Strukt. Khim.* 16 (1975) 920; *J. Struct. Chem. USSR* (1976) 855.
- [126] K. Ösapay, J. Delhalle, K.M. Nsunda, E. Rolli, R. Houriet, L. Hevesi, *J. Am. Chem. Soc.* 111 (1989) 5028.
- [127] L. Hevesi, *Phosphorus, Sulfur, and Silicon* 67 (1992) 155.
- [128] L. Hevesi, *Phosphorus and Sulfur* 38 (1988) 191 and references therein.
- [129] M. Yoshimatsu, T. Sato, H. Shimizu, M. Hori, T. Kataoka, *J. Org. Chem.* 59 (1994) 1011.
- [130] D. Derouane, J.N. Harvey, H.G. Viehe, *J. Chem. Soc. Chem. Commun.* (1995) 993.
- [131] G.P. Ford, K.S. Raghuvver, *Tetrahedron* 44 (1988) 7489.
- [132] T.P. Hamilton, H.F. Schaefer III, *J. Am. Chem. Soc.* 112 (1990) 8260.
- [133] C.H. Reynolds, *J. Chem. Soc. Chem. Commun.* (1990) 1533.
- [134] C.H. Reynolds, *J. Am. Chem. Soc.* 114 (1992) 8676 and references therein.
- [135] J.L. Holmes, F.P. Lossing, R.A. McFarlane, *Int. J. Mass Spectrom. Ion Processes* 209 (1988) 86.
- [136] G. Frenking, S. Fau, C.M. Marchand, H. Grützmacher, *J. Am. Chem. Soc.* in press.
- [137] U. Pidun, M. Stahl, G. Frenking, *Chem. Eur. J.* 2 (1996) 869.
- [138] This ordering is not altered when equation $X_nCH_{3-n} + CH_4^*X_nCH_{4-n} + CH_3^*$ ($X=OH, SH, SeH, TeH$) is used instead of Eq. (10) in Section 6.1. However, the energy gap between the oxo and other chalcogeno-substituted ions becomes considerably smaller (see Fig. 8 for an illustration).
- [139] D. Cremer, *Angew. Chem. Int. Ed. Engl.* 23 (1984) 627.
- [140] R.H. Martin, F.W. Lampe, R.W. Taft, *J. Am. Chem. Soc.* 88 (1966) 1353.
- [141] D.W. Berman, V. Anicich, J.L. Beauchamp, *J. Am. Chem. Soc.* 101 (1979) 1239.
- [142] L. Andrews, J.M. Dyke, N. Jonathan, N. Keddar, A. Morris, *J. Phys. Chem.* 88 (1984) 1950 and references therein.
- [143] M.E. Jacox, D.E. Milligan, *J. Chem. Phys.* 54 (1971) 3935.
- [144] H. Vancik, K. Perac, D.E. Sunko, *J. Am. Chem. Soc.* 112 (1990) 7418.
- [145] G.A. Olah, G. Laing, Y.K. Mo, *J. Org. Chem.* 39 (1974) 2394.
- [146] G.K.S. Prakash, L. Heiliger, G.A. Olah, *J. Fluorine Chem.* 49 (1990) 33.
- [147] G.A. Olah, M. Stephenson, J.G. Shih, V.V. Krishnamurthy, G.K.S. Prakash, *J. Fluorine Chem.* 40 (1988) 319.
- [148] G.A. Olah, G. Rasul, L. Heiliger, G.K.S. Prakash, *J. Am. Chem. Soc.* 118 (1996) 3580.
- [149] M. Kaupp, submitted for publication.
- [150] R. Weiß, M. Rechinger, F. Hampel, *Angew. Chem. Int. Ed. Engl.* 33 (1994).
- [151] R.J. Gillespie, E.A. Robinson, *Angew. Chem. Int. Ed. Engl.* 35 (1996) 477.